

RNA-mediated interaction of Cajal bodies and U2 snRNA genes

Mark R. Frey and A. Gregory Matera

Department of Genetics and Program in Cell Biology, Case Western Reserve University, Cleveland, OH 44106

Cajal bodies (CBs) are nuclear structures involved in RNA metabolism that accumulate high concentrations of small nuclear ribonucleoproteins (snRNPs). Notably, CBs preferentially associate with specific genomic loci in interphase human cells, including several snRNA and histone gene clusters. To uncover functional elements involved in the interaction of genes and CBs, we analyzed the expression and subcellular localization of stably transfected artificial arrays of U2 snRNA genes. Although promoter substitution arrays colocalized with CBs, constructs containing intragenic deletions did not. Additional experiments

identified factors within CBs that are important for association with the native U2 genes. Inhibition of nuclear export or targeted degradation of U2 snRNPs caused a marked decrease in the levels of U2 snRNA in CBs and strongly disrupted the interaction with U2 genes. Together, the results illustrate a specific requirement for both the snRNA transcripts as well as the presence of snRNPs (or snRNP proteins) within CBs. Our data thus provide significant insight into the mechanism of CB interaction with snRNA loci, strengthening the putative role for this nuclear suborganelle in snRNP biogenesis.

Introduction

Since their discovery nearly a century ago, Cajal bodies (CBs)* have eluded researchers as to their exact function(s), despite an ever-increasing knowledge of their structure, formation, and molecular composition. With the advent of fluorescent *in situ* techniques in the past decade, much effort has been devoted to understanding the role of the CB in the cell nucleus. CBs are marked by the presence of a signature protein, p80 coilin, which self-interacts and appears to be involved in the assembly/disassembly of this nuclear suborganelle (Hebert and Matera, 2000). In addition to coilin, a diverse array of other nuclear factors concentrates in CBs. The cellular duties of these factors include RNA biogenesis, transcription, and cell cycle control (for reviews see Matera, 1999; Gall, 2000). More specifically, a subset of these factors, the uridine-rich (U) small nuclear ribonucleoproteins (snRNPs), are involved in pre-mRNA splicing, pre-rRNA processing, and histone mRNA 3' maturation.

Address correspondence to Greg Matera, Department of Genetics, Case Western Reserve University, 10900 Euclid Ave., Cleveland, OH 44106-4955. Tel.: (216) 368-4922. Fax: (216) 368-3432. E-mail: gxm26@po.cwru.edu

M.A. Frey's present address is Athersys, Inc., Cleveland, OH 44115-2634.

*Abbreviations used in this paper: CB, Cajal body; CBC, cap-binding complex; DSE, distal sequence element; IF, immunofluorescence; LMB, leptomycin B; NES, nuclear export signal; PNA, peptide nucleic acid; PSE, proximal sequence element; RSV, Rous Sarcoma virus; SMN, spinal muscular atrophy protein; snRNP, small nuclear ribonucleoproteins; TMG, tri-methyl guanosine; U, uridine-rich.

Key words: snRNPs; snRNAs; RNU2 loci; nuclear bodies; RNA processing

The spinal muscular atrophy protein (SMN) provides a link between CBs and disease (Matera, 1999). SMN protein is distributed throughout the cytoplasm but it also concentrates in CBs and nuclear foci called gems (Liu and Dreyfuss, 1996). In fact, gems and CBs are completely coincident in many cell types (Matera and Frey, 1998; Carvalho et al., 1999; Young et al., 2000). SMN is part of a large protein complex that plays a role in biogenesis of the Sm class of U snRNPs (Fischer et al., 1997; Charroux et al., 1999; Meister et al., 2000). The life cycle of Sm snRNPs begins with transcription in the nucleus followed by export to the cytoplasm (Ohno et al., 2000) for maturation (i.e., Sm protein assembly, tri-methyl guanosine [TMG] capping, and 3' end processing). Newly assembled snRNPs are believed to target initially to CBs upon nuclear reentry, and then proceed on to other nuclear compartments including interchromatin granule clusters (or speckles) and perichromatin fibrils (Sleeman and Lamond, 1999a). At steady-state, high concentrations of splicing snRNPs accumulate in CBs, yet splicing does not occur within them (Carmo-Fonseca et al., 1992; Matera and Ward, 1993). These data underscore the role for CBs in the biogenesis of Sm snRNPs.

CBs are dynamic structures that disassemble during mitosis and reassemble in mid-G1 phase after the resumption of transcription (Andrade et al., 1993; Carmo-Fonseca et al., 1993). Treatment with various transcription or nuclear export inhibitors causes snRNPs to depart from CBs and accumulate in interchromatin granule clusters, indicating a

flux of CB components (Carmo-Fonseca et al., 1992; Carvalho et al., 1999).

Some years ago, we discovered a relationship between CBs and certain genomic loci in interphase cells. Using FISH and immunofluorescence (IF), we and others demonstrated that CBs are nonrandomly associated with human genes encoding snRNAs, snoRNAs, and histone mRNAs (Frey and Matera, 1995; Smith et al., 1995; Gao et al., 1997; Schul et al., 1998; Jacobs et al., 1999; Frey et al., 1999; Smith and Lawrence, 2000; Shopland et al., 2001). The interaction with histone loci is conserved among amphibians and may be explained by the presence of the U7 snRNP within CBs (Frey and Matera, 1995; Gall et al., 1995). In this way, CBs could impose a level of regulation on histone mRNA production by providing critical RNA processing factors. Hence, association of histone genes and CBs might very well be mediated by the interaction of U7 with nascent or newly transcribed histone mRNA.

However, the association of CBs with snRNA genes is not as easily interpreted. Given that CBs contain (partially) mature U snRNPs and associate with the genes that encode them, an autogenous feedback regulation model has been proposed (Frey and Matera, 1995; Matera, 1998; Frey et al., 1999). Using artificial U2 gene constructs, we identified some of the functional elements required for association of human U2 genes (*RNU2* loci) with CBs (Frey et al., 1999) and found that the promoter was necessary for the interaction. Moreover, inhibition of ongoing transcription abolished CB association. However, the most telling result came from a construct in which the U2 coding region was replaced by a heterologous sequence. This construct revealed a requirement for the U2 coding region as well. It also suggested an interaction (direct or indirect) of CBs with snRNA transcripts.

In this report, we have extended our previous study of the *RNU2*-CB interaction to identify additional functional components. By assembling artificial tandem arrays of mutant *RNU2* constructs, we found that substitution of the snRNA-specific U2 promoter with a viral one did not inhibit the *RNU2*-CB association. Furthermore, another construct showed that transcription of sequences downstream of the U2 3' box element is not sufficient for CB colocalization. Consistent with the requirement for the U2 coding region, artificial arrays containing an intragenic deletion of stem loop IV of U2 snRNA failed to associate with CBs. Additional experiments revealed the importance of U2 snRNPs within the CB in order to achieve association with U2 genes. Microinjection of antisense U2 oligonucleotides resulted in degradation of U2 snRNPs within CBs and abolished the *RNU2*-CB association. Further, the effects of the antisense U2 oligomers were specific since they had no effect on the interaction of CBs with *RNU1* loci. Similarly, depletion of snRNAs from CBs by inhibiting export of newly synthesized transcripts also inhibited the *RNU2*-CB interaction. We also show that gems, which do not contain snRNPs, do not associate with CBs. Together, these experiments underline the need for specific CB factors that presumably recognize nascent or newly transcribed RNAs and mediate the interaction with their cognate genes.

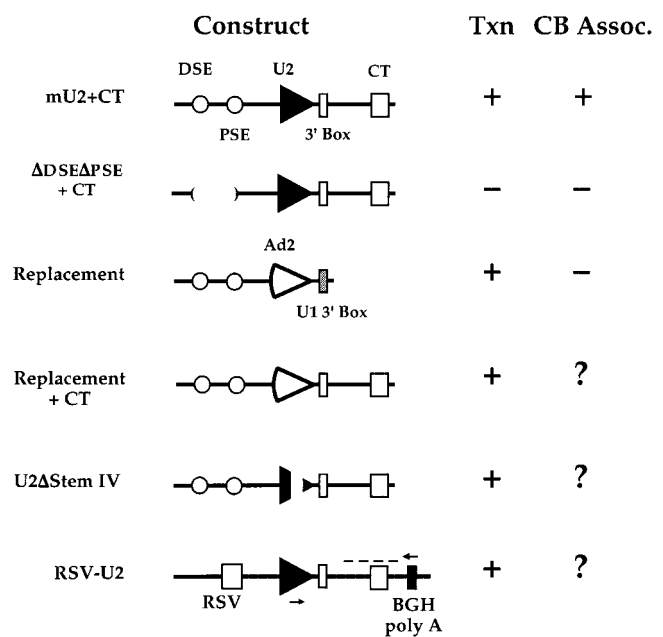

Figure 1. **Constructs used to create artificial tandem arrays.** The top three constructs were described previously (Frey et al. 1999); the bottom three were used in this study. DSE and PSE (circles) are distal and proximal enhancers, respectively. Deletions are denoted by parentheses. Arrowheads mark coding regions; the filled ones represent the U2 coding region, whereas the open arrowheads depict the replacement sequence. The 3' box is an element required for proper 3' end processing of snRNAs. CT is a microsatellite repeat. The RSV-U2 construct incorporates an RSV promoter upstream of the U2 coding region and a bovine growth hormone polyadenylation signal (BGH poly A) downstream of the CT element. Primers used for RT-PCR are indicated by arrows. The dashed line denotes the location of a cryptic intron (see text). Results of transcription (Txn) and CB association (CB Assoc.) experiments for stable arrays of the corresponding constructs are also shown.

Results

Transcription of downstream U2 sequences is insufficient for CB association

The structure of class II snRNA genes consists of specialized RNA pol II promoter elements, the RNA coding region, and a 3' box (for review see Henry et al., 1998). The 3' box is an ~13-bp motif located 9–20 bp downstream of the coding region. Initially, these snRNA genes are transcribed to produce 3'-extended precursors that are further processed to mature snRNAs in the cytoplasm (Huang et al., 1997; Zhou et al., 1999). Although rather tolerant of changes, mutation of the 3' box signal results in longer snRNA transcripts. Accurate processing also requires an intact snRNA promoter, providing evidence that snRNA precursors are formed either by termination of transcription or by a processing event that is coupled to transcription (Hernandez and Weiner, 1986). Recent evidence (Cuello et al., 1999) demonstrates that human *RNU2* transcription often continues well beyond the 3' box element. Additionally, Smith and Lawrence (2000) detected in situ the frequent presence of transcripts corresponding to a region previously thought to be nontranscribed spacer DNA. Thus, pol II transcribes sequences located far downstream of the U2 coding region.

A

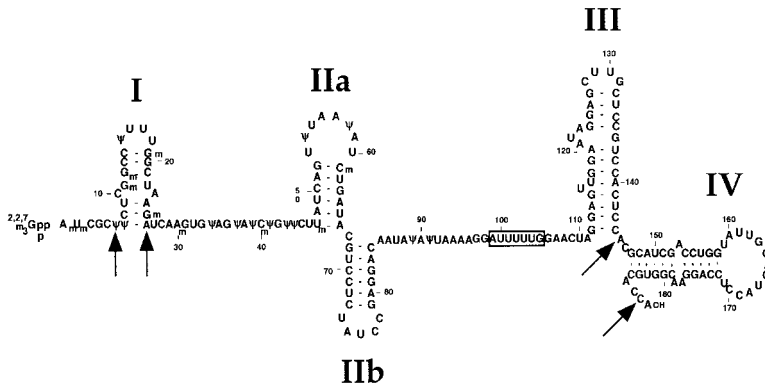

B

Cell line	<u>AdCT1A5</u>	<u>AdCT1C1</u>	<u>S41D1</u>	<u>S42D1</u>	<u>S42D2</u>
# cells scored	60	100	157	60	100
CB Assoc. Freq.	0%	0%	6%	0%	0%
Mean CB #	1.6	1.7	1.3	1.8	1.4
Gene copy #	10	10	5	7	5
	Replacement+CT		U2ΔStem IV		

Our previous work showed that deletion of promoter and enhancer elements within U2 repeats abolished association of artificial U2 arrays with CBs (Fig. 1; Frey et al., 1999). This led us to test a construct in which the U2 coding region was replaced by a sequence from the adenovirus 2 major late intron (Hernandez and Weiner, 1986). Interestingly, arrays of this construct were transcribed but never colocalized with CBs (Fig. 1; Frey et al., 1999). In light of the recent evidence that U2 downstream sequences are transcribed, and coupled with the fact that our original “Replacement” construct did not contain these downstream sequences, we created a new construct termed Replacement+CT (Fig. 1). Replacement+CT contains not only the adenovirus sequence driven by the U2 promoter, but includes the identical U2 downstream sequences that are present in the mini-gene construct, mU2+CT (Fig. 1).

We therefore assembled arrays of Replacement+CT monomers, stably transfected them into HT1080 cells, and screened resistant colonies by Southern blot. Two cell lines (AdCT1A5 and AdCT1C1) were chosen for further analysis. After IF with anticoinin and subsequent FISH, we scored cells for association of CBs with Replacement+CT loci and found no colocalization of CBs with Replacement+CT genes (Figs. 2 B and 3). Endogenous U2 loci were distinguished from transfected genes using a differentially labeled PCR probe which only hybridizes to wild-type U2 arrays (Frey et al., 1999). Since CB association is dependent on transcription, we performed RNA FISH to confirm transcription of the Replacement+CT arrays. As seen in Fig. 3 D, the Replacement+CT loci are expressed. The Replacement+CT construct yielded results similar to the Replacement arrays, leading to the conclusion that U2 down-

stream sequences do not interact with CBs in the absence of the U2 coding region.

Deletion of sequences within the U2 coding region disrupts CB colocalization

The results of experiments using the Replacement and Replacement+CT constructs strongly confirm the absolute requirement for the U2 coding region in the association with CBs. Therefore, we decided to mutate various parts of the U2 coding region and analyze the effects on the association with CBs. Though the U2 gene is short (188 bp), there are several conserved structural and sequence elements (Fig. 2 A), including (i) the 5' end and stem-loop I, which functions in essential base pairing with U6 during splicing and also bind U2 specific factors (Wu and Manley, 1991); (ii) a single-stranded region that recognizes the branchpoint during splicing and separates stem loops I from IIa; (iii) the Sm binding site (boxed sequence) located between stems IIb and III, which assembles Sm proteins and is essential for U2 biogenesis; and (iv) stem loop IV which binds the U2-specific proteins, B' and A'. These important and conserved structural features play substantial roles in snRNP biogenesis and splicing. Given that U2 snRNA is needed for CB colocalization, we therefore deleted two of these elements (stem loops I and IV) and then assayed artificial arrays of the mutant U2 genes for association with CBs. Using PCR-mediated mutagenesis, an EcoRI site replaced each deleted sequence (see Materials and methods). Arrays of the stem I and IV deletion constructs (U2ΔstemI and U2ΔstemIV) were assembled in vitro and stably transfected into HT1080 cells.

We were unable to isolate stable cell lines containing U2ΔstemI genes. After repeated transfections and selection,

Figure 2. (A) The sequence and secondary structure of the human U2 snRNA is shown. The boxed element marks the Sm protein binding site. Arrows indicate boundaries of deletion constructs for stem loop I (6–26) and IV (145–187). (B) Arrays of Replacement+CT and U2ΔStemIV constructs do not associate with CBs. Two Replacement+CT cell lines (AdCT1A5 and AdCT1C1) and three U2ΔstemIV lines (S41D1, S42D1, and S42D2) were scored as described previously (Frey et al., 1999). The CB association frequencies were calculated by dividing the number of exogenous U2 loci colocalized with a CB by the total number of associated U2 loci. Gene copy number and average number of CBs/cell are also shown.

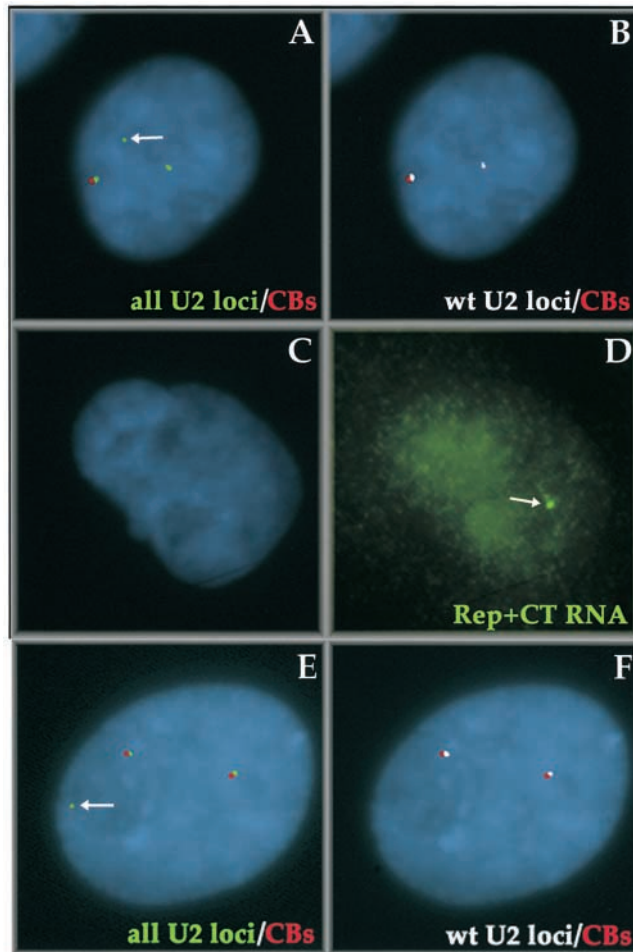

Figure 3. FISH and IF of artificial U2 arrays. (A and B) Replacement+CT arrays do not associate with CBs. Endogenous *RNU2* loci (B) are shown in white; all U2 loci (A) are shown in green. CBs are shown in red. DAPI-stained nuclei are shown in blue. As seen in A, Replacement+CT arrays never colocalized with CBs (arrow). (C and D) Replacement+CT arrays are transcribed, as demonstrated by the RNA-FISH signal (D). The same nucleus stained with DAPI is shown in C. (E and F) Deletion of sequences encoding stem loop IV of U2 snRNA also disrupts association with CBs. DNA FISH/IF images show that CBs do not interact with U2 Δ stemIV arrays (E, arrow), whereas association with wild-type *RNU2* loci is unaffected (F).

no colonies were recovered. This is most likely due to dominant-negative effects of these mutants on splicing since stem loop I, in addition to its vital base-pairing interactions with U6 snRNA, binds essential splicing factors SF3a and SF3b (Yan and Ares, 1996). We did, however, obtain surviving colonies from U2 Δ stemIV gene transfections. We screened G418-resistant colonies and isolated three cell lines harboring U2 Δ stemIV arrays. Upon scoring \sim 100 cells for each cell line by FISH and IF, we rarely observed U2 Δ stemIV genes associated with CBs (Fig. 3, E and F). In fact, two of the three cell lines showed no CB colocalizations at all (Fig. 2 B).

Primer extension analysis on total RNA from U2 Δ stemIV cell lines showed an extremely low steady-state level of expression of the transgenes (data not shown). A dearth of nascent U2 Δ stemIV transcripts might in itself result in re-

duced CB association frequencies. Alternatively, transcription could be initiated regularly, but the U2 Δ stemIV RNA may be unable to bind U2B^{''}, rendering it unstable. U2B^{''} is known to play important roles in the both the stability and function of U2 snRNPs (Caspary and Seraphin, 1998). Thus dominant-negative effects on splicing may result in survival of only those cells expressing low levels of the U2 Δ stemIV gene product (see Discussion).

Transcription of the U2 coding region is sufficient for CB association

The snRNA promoters form a class of the most powerful pol II promoters in the genome (Mangin et al., 1986). They are comprised of a TATA-less proximal sequence element (PSE) and a distal sequence element (DSE). The PSE serves as a basal promoter, whereas the DSE enhances transcription. The snRNA promoters attract a unique pol II complex, containing snRNA-specific transcription factors. These factors form a complex of five subunits, called SNAPc (Henry et al., 1995) or PTF (Yoon et al., 1995). SNAPc binds the PSE and interacts with transcriptional enhancers that bind the DSE, such as Oct1. Without these elements, extended versions of snRNA transcripts are produced. Exchange of the snRNA promoter with a TATA-containing mRNA promoter results in production of longer polyadenylated snRNAs (Hernandez and Weiner, 1986).

U2 genes lacking promoters do not associate with CBs (Frey et al., 1999). It is possible that the U2 promoter elements and/or the PSE-binding SNAPc factors play a role in the interaction of U2 genes with CBs. One of the common themes among genes that interact with CBs is that their promoters are quite similar. In fact, histone and snRNA promoters are interchangeable without deleterious effects on 3' end processing (Pilch and Marzluff, 1991). Association of CBs with a gene driven by a classical mRNA promoter has yet to be observed (Frey and Matera, 1995; Smith et al., 1995; Jacobs et al., 1999). Is transcription from an snRNA promoter necessary for CB colocalization? To answer this question, we assembled a hybrid construct consisting of the Rous Sarcoma virus (RSV) promoter (Overbeek et al., 1986) driving the U2 coding region (RSV-U2; Fig. 1). Again, after selection and screening, six stably transfected lines harboring arrays of RSV-U2 were analyzed. As expected, primer extension revealed low levels of steady-state RNA production. Based on earlier studies (Hernandez and Weiner, 1986), we anticipated that such a construct would produce an RNA that is improperly processed and unstable. Consistent with these results, we were unable to detect these transcripts by Northern blotting (data not shown). We next performed RT-PCR as described in Fig. 4 A, and then cloned and sequenced the resultant products. As expected, the RSV-U2 RNA was polyadenylated. To our surprise, however, the products were smaller than expected. Sequencing identified a cryptic intron within the U2 downstream flanking region (Fig. 4 A).

Upon scoring cells from these lines, we found that RSV-U2 loci do, indeed, colocalize with CBs (Fig. 4 B, arrow, and C). We monitored the relative steady-state RNA production of the transfected genes by primer extension (Bailey

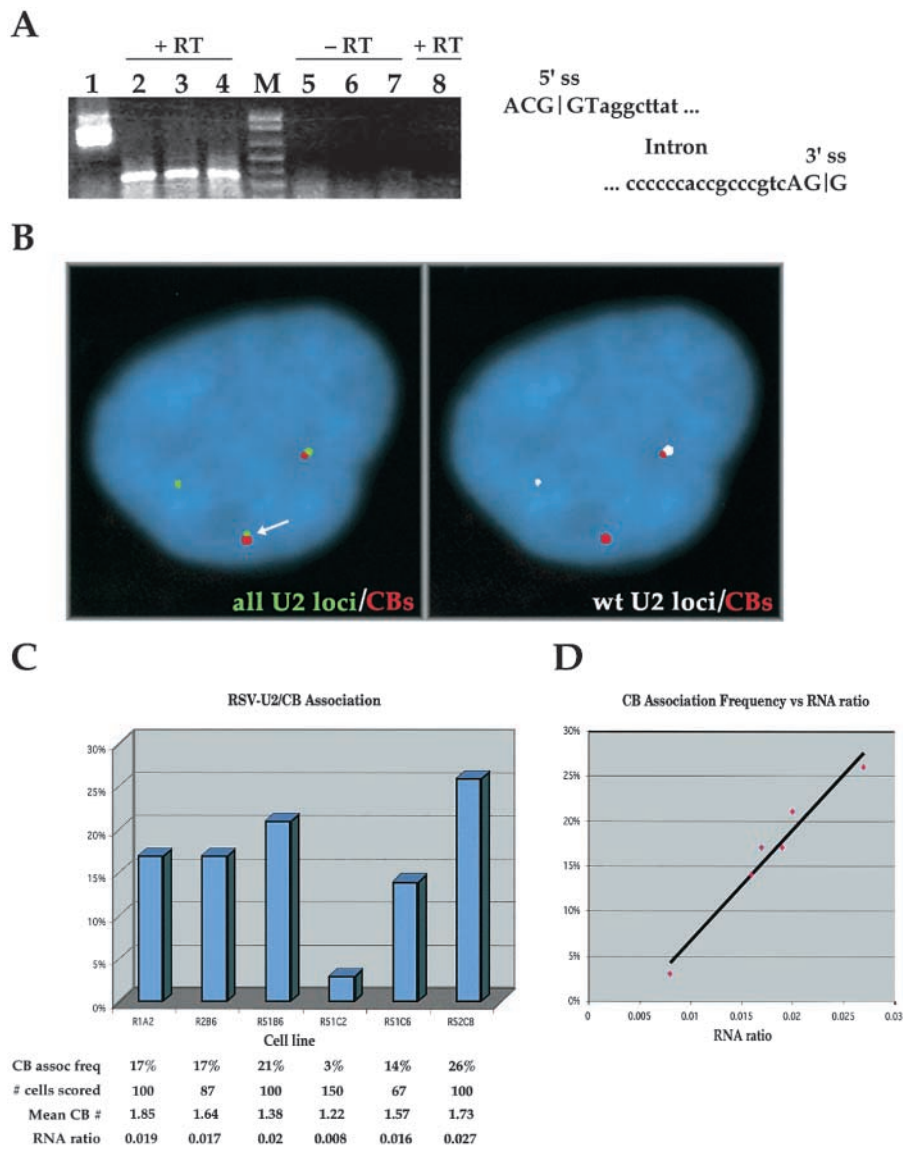

Figure 4. RSV-driven U2 genes interact with CBs. (A) RT-PCR was performed on total RNA isolated from RSV-U2 cell lines using an oligo-dT primer for first-strand synthesis in the presence (+RT) or absence (-RT) of reverse transcriptase. Subsequently, PCR products with primers shown in Fig. 1 were separated on an agarose gel. (Lane 1) Positive control template, pRSV-U2 DNA. (Lanes 2–4) RNA from cell lines R51B6, R1A2, and R51C6. M, marker. (Lanes 5–7) R51B6, R1A2, and R51C6. (Lane 8) Negative control cell line (iU2A37) with an artificial array of wild-type U2 genes (Frey et al., 1999). Sequencing revealed the presence of an intron within the RSV-U2 RNA. The sequence around the intron junction is shown at right. (B) DNA FISH and IF demonstrate colocalization of CBs with RSV-U2 genes. Arrow marks the RSV-U2 locus. The probes used are denoted by color-coded text at bottom of each panel. (C and D) Data collected from RSV-U2 cell lines. The y axis of each graph represents CB association frequency. The graph on the left (C) shows results of scoring experiments and characterization of RSV-U2 cell lines. On the right (D) is a graph of CB association frequency versus RNA ratio, revealing a linear correlation. The RNA ratio represents the steady-state level of exogenous U2 RNA divided by the endogenous amount.

et al., 1995; Frey et al., 1999). Expression was measured by comparing the intensity of the exogenous primer extension band, divided by that of the endogenous genes to generate an RNA ratio (Fig. 4 D). Polyadenylated U2 snRNA does not normally exist in the cell and is apparently rapidly degraded since Northern blotting failed to detect a band. However, as shown previously for artificial U2 genes driven by natural snRNA promoters, the frequency of CB association with RSV-U2 arrays correlated linearly with the RNA ratio (Fig. 4 D). Since RSV-U2 genes associate with CBs and RSV promoters do not recruit SNAPc factors, we conclude that snRNA-specific transcription factors are not essential for interaction with CBs.

U2 genes do not associate with SMN gems

There are obviously two sides to the *RNU2*-CB interaction. Thus far, we have concentrated on the chromosomal side of the association. Are there also certain requirements for components on the CB side? We hypothesized that snRNPs returning from the cytoplasm and accumulating in CBs could

provide the cell with an opportunity for autogenous feedback regulation (Frey and Matera, 1995; Matera, 1998; Frey et al., 1999). Thus, it seemed possible that the presence of (partially) mature snRNPs within the CB might be necessary for association with snRNA genes. We therefore analyzed a strain of HeLa cells, called HeLa-PV, in which SMN gems and CBs are often observed as separate structures (Liu and Dreyfuss, 1996; Matera and Frey, 1998; Sleeman and Lamond, 1999b). In those instances when CBs and gems occupy distinct locations, snRNPs invariably reside in the coilin-positive CBs and are not detectable in SMN gems. Growing the HeLa-PV cells at 32°C can exacerbate the separation phenotype (Liu and Dreyfuss, 1996). In this case, we wanted to determine whether U2 genes associate with snRNP-positive CBs or snRNP-negative SMN gems. To this end, we differentially labeled CBs and gems and subsequently hybridized a DNA probe to *RNU2* loci. Of all cells examined ($n > 100$), not one exhibited an *RNU2* array colocalized with a gem (Fig. 5). Thus U2 genes always colocalized with snRNP- and coilin-positive CBs.

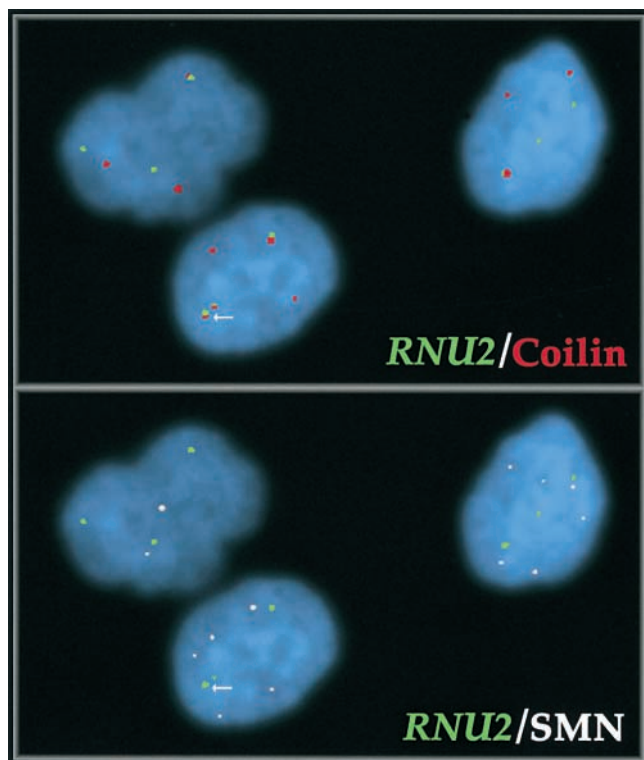

Figure 5. SMN gems, which lack snRNPs, do not colocalize with *RNU2* loci. For better separation of gems and CBs, HeLa-PV cells were grown at 32°C before fixation and staining with anticoilin (top, red) and anti-SMN (bottom, white) antibodies. Subsequently, DNA FISH was performed with an *RNU2* probe to detect U2 genes (green signals, both panels). Of the ~100 cells examined, *RNU2* loci were never observed to overlap with non-snRNP-containing SMN gems. Arrows mark a *RNU2*-CB association (top) that does not colocalize with a gem (bottom).

The *RNU2*-CB interaction requires ongoing nuclear transport

Carvalho et al. (1999) showed that treatment of cells with leptomycin B (LMB), a known inhibitor of exportin1/CRM1-mediated nuclear export (Kudo et al., 1998), resulted in the progressive depletion of snRNPs from CBs. Presumably, if newly transcribed snRNAs are prevented from leaving the nucleus, then newly assembled snRNPs will be depleted first from the cytoplasm and then from CBs (Carvalho et al., 1999). We reasoned that such a disruption of the snRNP cycle would also have an effect on the association of CBs with U2 genes. HeLa cells were thus incubated in media containing LMB and assayed. As shown in Fig. 6 A (compare -LMB with +LMB), we monitored the presence of U2B^{''} protein in CBs as a marker for the U2 snRNP. The kinetics of disappearance of U2 snRNPs from CBs were very similar to those observed by Carvalho et al. (1999). Interestingly, the effects of U2 snRNP depletion from CBs are mirrored by a striking decrease in the *RNU2*-CB association frequency (Fig. 6, A and B). Although the effects of LMB on the *RNU2*-CB interaction can be seen in as short as 2 h of treatment, the association frequency decreases with increasing incubation time (Fig. 6 B). Thus, U2 genes no longer associate with CBs when snRNA export is blocked by LMB.

The potentially pleiotropic effects imposed by LMB prompted us to search for a more focussed approach at disrupting the snRNP maturation cycle. PHAX binds cooperatively with exportin1, Ran-GTP, and the cap-binding complex (CBC) to export snRNAs in *Xenopus* oocytes (Ohno et al., 2000). We attempted to block snRNA export using a mutant form of PHAX containing changes in its nuclear export signal (NES). This mutant is able to bind the CBC, but cannot incorporate into a complex with exportin1 and Ran-GTP, and thus acts in a dominant-negative fashion on snRNA export when high concentrations of the protein are injected into *Xenopus* oocytes (Ohno et al., 2000). To this end, we fused both wild type and NES-mutant PHAX to the NH₂ terminus of GFP and transfected the constructs into HeLa cells. Both constructs localized to the nucleoplasm, as expected. Surprisingly, they also accumulated in CBs as shown by costaining with anticoilin (Fig. 6 C, arrows). Unfortunately, we did not detect any significant perturbation of snRNPs within the CB, as measured by staining for Sm proteins, U2B^{''} or by hybridization with antisense U2 oligos (data not shown). The snRNP localization pattern in transfected versus untransfected cells was indistinguishable.

Thus, since the PHAX-NES mutant did not appear to have an effect on U2 accumulation in CBs, its utility in our assay system was minimal. However, despite the apparent lack of dominant-negative effects of PHAX-NES-GFP overexpression in mammalian cells, the localization data presented here are noteworthy because they implicate CBs in early steps of snRNA metabolism (see Discussion).

U2 snRNPs are required for the *RNU2*-CB association

To directly assess the importance of snRNPs within CBs for their interaction with U2 genes, we tested the effects of U2 snRNA depletion by microinjecting antisense deoxyoligonucleotides into HeLa cells. This technique relies on endogenous RNaseH activity to disrupt RNAs. It has been performed successfully by many other laboratories to specifically target snRNPs for in vivo degradation (e.g., Pan and Prives, 1988; O'Keefe et al., 1994). For example, injection of antisense U1 oligos into *Xenopus* oocytes does not affect the stability of U2 snRNA, and vice versa. Therefore, we microinjected either random control or anti-U2 oligonucleotides into the cytoplasm of HeLa cells and assayed their effects on the *RNU2*-CB interaction.

2 h after microinjection, the cells were fixed and hybridized with a biotinylated peptide nucleic acid (PNA) probe to localize U2 snRNA. Injected cells were identified by coinjecting a fixable Texas red-conjugated dextran that cannot diffuse through the nuclear pore and thus remains in the cytoplasm. As shown in Fig. 7 A, both the intensity of U2 snRNA in the CBs and the nucleoplasmic speckled pattern were dramatically reduced when compared with noninjected cells. Moreover, microinjection of control oligos had little or no effect (Fig. 7 A). Staining with anti-U2B^{''} confirmed the reduced levels of U2 snRNP throughout the nucleoplasm as well as within CBs (data not shown). Again, no effect was observed upon injection of control oligos.

Strikingly, we found that only ~20–25% of cells injected with antisense U2 oligos displayed an association of CBs

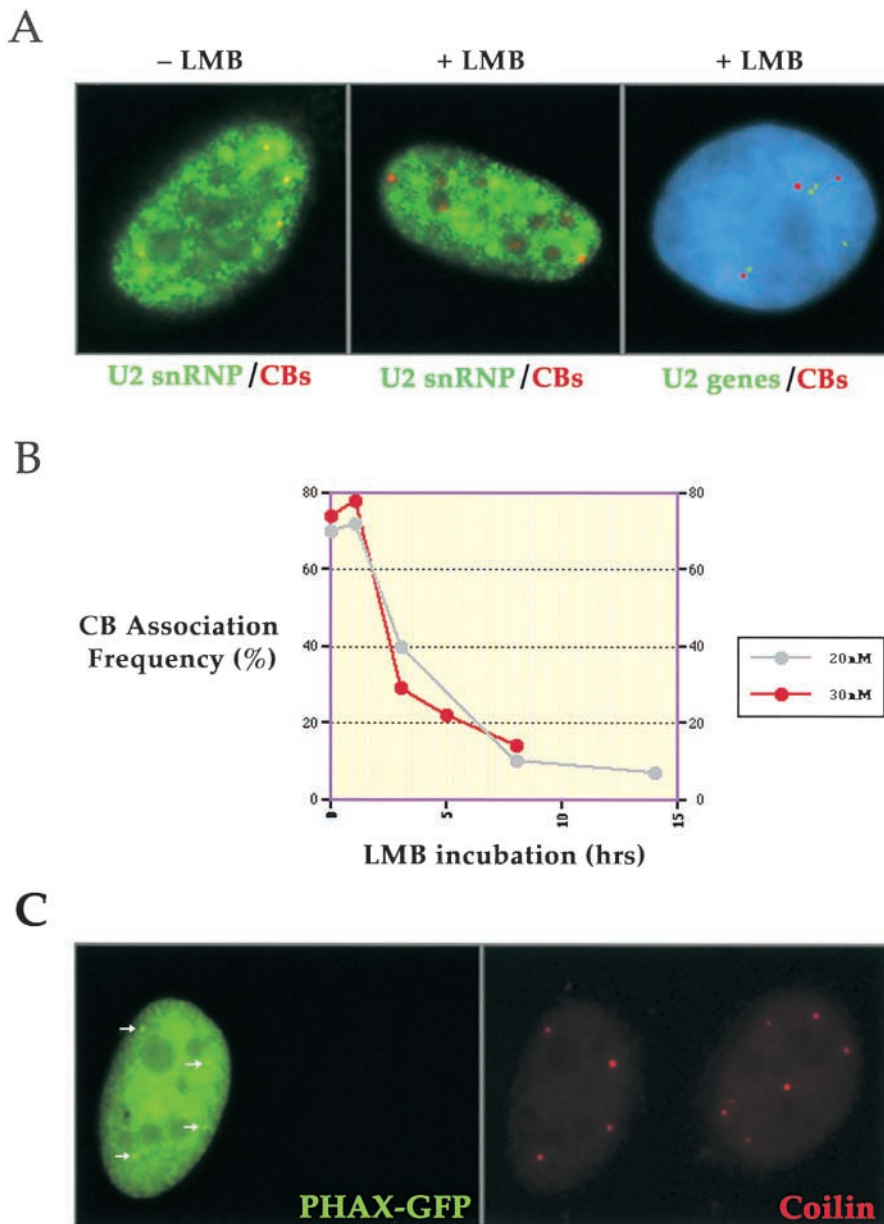

Figure 6. Inhibition of snRNA export disrupts *RNU2*–CB association. (A) HeLa cells were incubated in the presence or absence of LMB for 3 h and then stained with anti-U2B^{''} (green) and anti-coilin antibodies (red). At early time points (3–5 h) CBs remain prominent; although, diffuse accumulation of coilin within nucleoli is also observed (Carvalho et al., 1999). The presence of U2 snRNPs in CBs on the left is demonstrated by the yellow color. The lack of signal overlap is evident in the middle (note red color). On the right, FISH reveals that CBs (red) and U2 genes (green) do not colocalize. (B) CB association with U2 genes decreases with increasing incubation time in LMB. (C) HeLa cells were transfected with PHAX–GFP and costained with antioilain. In addition to localization throughout the nucleoplasm, note accumulation of PHAX–GFP (green) within the CBs (red) of the transfected cell.

with *RNU2* loci, whereas the frequency in uninjected cells or cells injected with control oligos was 65–75% (Fig. 7, C and D). The effects on U2 genes was specific, as microinjection of antisense U2 oligos had no effect on the frequency of CB association with U1 genes (Fig. 7 D). These data highlight the specific nature of the interaction between CBs and snRNA genes and provide an important line of evidence demonstrating the requirement for individual snRNPs within CBs in order to interact with their cognate genetic loci.

Discussion

From these studies, a better understanding of the interaction of CBs and U2 genes has emerged. We extended our previous analysis by testing additional mutant U2 gene constructs to identify functional elements within *RNU2* genes that are essential for association with CBs. Although transcription of an intact U2 coding region is vital, sequences downstream are

not sufficient to interact with CBs. Our promoter–swap construct, in which the U2 gene is driven by a viral promoter, demonstrates that snRNA-specific transcription factors (e.g., SNAPc) are not required for CB colocalization. These data suggest that transcription of the U2 snRNA alone is sufficient. We have also shown that *RNU2* loci fail to interact with empty CBs. Depletion of U2 snRNPs from CBs by either inhibition of nuclear export or by RNaseH-mediated degradation of the snRNA prevents CB association with U2 genes.

U2 snRNA readthrough transcription

Two lines of evidence indicate that transcription of the human U2 tandem repeat often proceeds far beyond the U2 3' box (Cuello et al., 1999; Smith and Lawrence, 2000). These findings prompted us to create and analyze the Replacement+CT arrays (Fig. 1). Our previous observation that Replacement+CT arrays never colocalized with CBs (Frey et al., 1999) suggested that the U2 coding region

Figure 7. RNaseH-mediated degradation of U2 snRNPs inhibits interaction of CBs and U2 genes.

(A) HeLa cells were microinjected in the cytoplasm with anti-U2 (top) or control (bottom) deoxyoligonucleotides, along with a Texas red–conjugated dextran. The dextran cannot diffuse through the nuclear pores and thus marks the injected cells. Note loss of the overall speckled pattern, including CB staining, in cells injected with anti-U2 oligomers, but not in cells injected with control oligos (arrow). (B) Injection of anti-U2 oligos had no effect on coilin staining. Prominent CBs are visible in injected cells (arrow), even when mistakenly injected in the nucleus (arrowhead). (C) Injected cells were processed for FISH/IF and then visually screened for those that retained significant Texas red signal in the cytoplasm to mark injected cells (arrow). Note lack of overlap between CBs (red dots in nucleoplasm) and FISH signals (green) in the injected cells. Arrowheads mark CBs that overlap with U2 genes in uninjected cells. (D) Using a dual-pass filter set, cells were scored for association of CBs with *RNU2* or *RNU1* loci in cells injected with either anti-U2 or control oligos (For columns 1–5, the number of cells scored was 100, 80, 80, 70, and 70, respectively). The CB association frequency represents the percentage of nuclei that had at least one overlapping pair of signals. Cells injected with control oligos had similar *RNU2*–CB association frequencies to those of uninjected cells. Injection of anti-U2 oligomers significantly inhibited the interaction of CBs with *RNU2*, but not with *RNU1* loci.

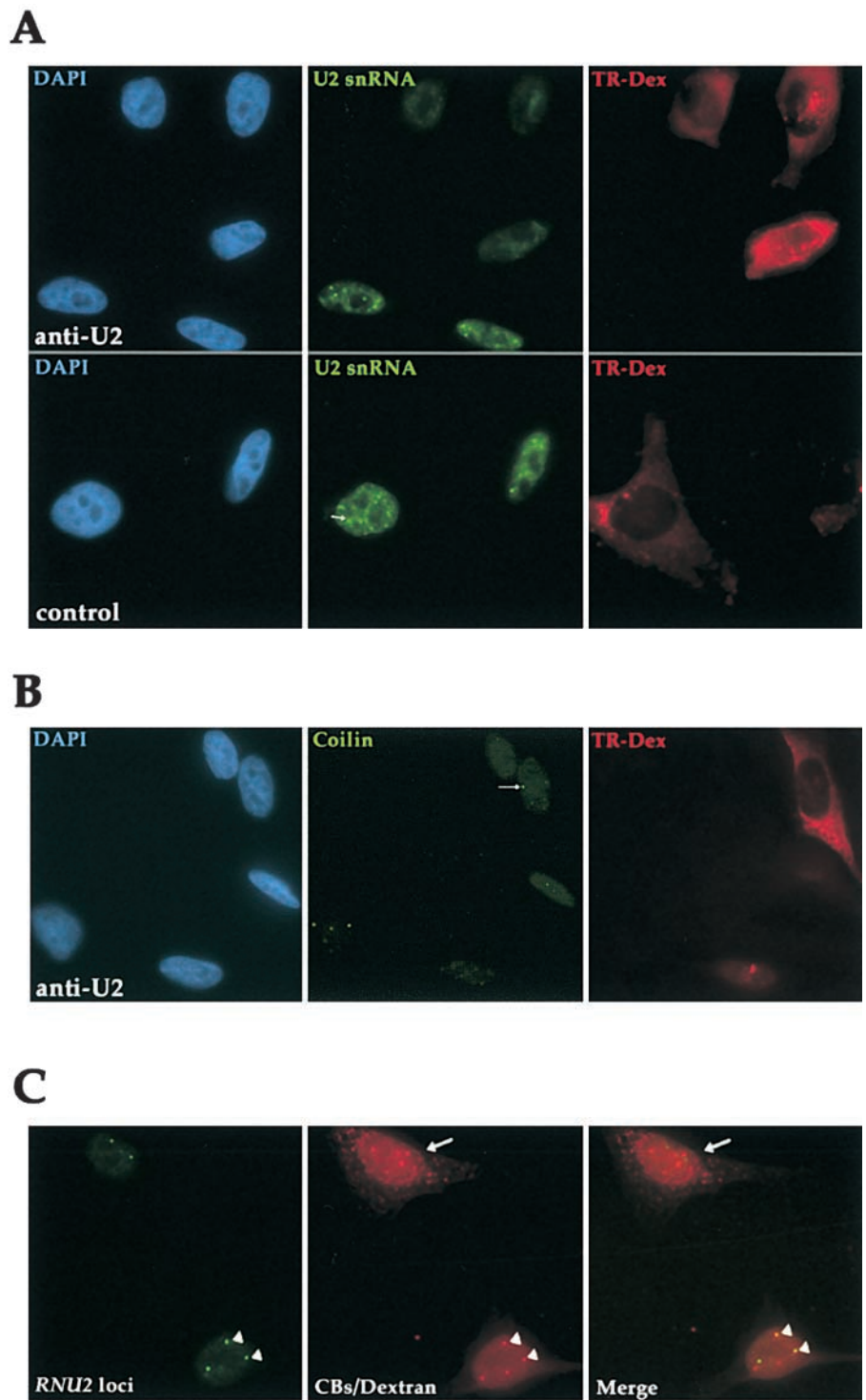

was sufficient but did not rule out the potential involvement of downstream sequences. The Replacement+CT construct tests the possibility of CB association with transcribed sequences that are located 3' of the U2 coding region. Although we discovered that Replacement+CT arrays do not interact with CBs (Figs. 2 and 3), the results do not rule out a function for the 3' region in CB association, but merely indicate that sequences downstream of the U2 coding region cannot direct CB colocalization in their absence.

RNA-mediated association

Our results are most consistent with recognition of the U2 RNA alone, rather than through a polymerase complex that contains snRNA-specific transcription factors. We found that U2 coding sequences expressed from an RSV promoter associated with CBs at frequencies comparable to those of wild-type U2 genes (Fig. 5). A priori, we would have predicted that the low steady-state levels of the RSV-U2 RNA would not favor interaction of these arrays with CBs. However, the fact that they do associate with CBs suggests that

D

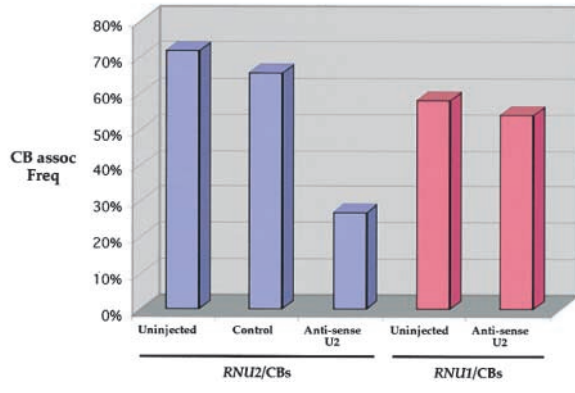

they are being actively transcribed. It is therefore possible that the unconventional form of the RSV-U2 RNA we detected by RT-PCR (i.e., one that is spliced and polyadenylated; Fig. 4) is rapidly degraded. This would result in an RNA ratio that, whereas linearly correlated with the CB association frequency (Fig. 5), does not accurately reflect the production of transcripts from RSV-U2 genes.

Given that CBs interact with *RNU2* loci through nascent or newly transcribed U2 snRNAs, what are the required features of this RNA? Are there structural elements or proteins that bind specific regions of U2 snRNA and mediate association with CBs? We attempted to answer these questions by introducing artificial U2 genes harboring deletions within the coding region. Unfortunately, we were unsuccessful in recovering cell lines containing U2 Δ stemI arrays. However, we did isolate stable lines containing U2 Δ stemIV genes and discovered that these arrays do not interact with CBs. Again, the lack of association could be due to a low steady-state level of nascent transcripts.

Alternatively, these intragenic deletions might have a profound effect on the stability of the RNA as well as on the association frequency with CBs. Indeed, deletion of *YIB9* (the U2B'' orthologue) in yeast reduces levels of the U2 snRNP, impairs pre-mRNA splicing, and retards growth (Caspary and Seraphin, 1998). Since U2 Δ stemIV RNA cannot bind U2B'', it would likely be degraded. Alternatively, this mutant RNA may poison the splicing reaction. If this were the case, only cells expressing modest amounts of U2 Δ stemIV RNA would survive, giving rise to decreased RNA ratios and CB association frequencies.

Finally, it is also possible that stem loop IV and/or U2B'' are directly involved in CB association and that deletion of this structural element destabilizes the U2 RNA and disrupts the interaction with CBs. Considering that U2B'' can enter the nucleus independently of the U2 snRNP (Kambach and Mattaj, 1994), this protein remains a candidate for binding nascent/newly transcribed U2 snRNA. Interestingly, a similar preexport role has been proposed for the U1A protein (Terns et al., 1993a,b), which is a close evolutionary relative to U2B'' (Polycarpou-Schwarz et al., 1996).

CBs and snRNA transport

Several lines of evidence suggest that CBs are involved in metabolism of snRNPs (for reviews see Matera, 1999; Sleeman and Lamond, 1999b; Gall, 2000; Lewis and Tol-

lervey, 2000). Plausibly, disruption of the snRNP biogenesis pathway could have effects on the U2 gene association with CBs. We tested this hypothesis by treating cells with LMB to inhibit snRNA export and found that it interfered with the *RNU2*-CB colocalization (Fig. 6). The implication is that CBs fail to interact with *RNU2* loci in LMB-treated cells because they do not contain the necessary factors (i.e., U2 snRNPs). However, since the effects of LMB treatment might well be indirect (CRM1-exportin mediates export of other proteins in addition to snRNAs), we decided to specifically deplete U2 snRNAs by microinjection of antisense oligonucleotides (Fig. 7). These experiments directly implicate U2 snRNA in the interaction of *RNU2* loci with CBs.

Moreover, two additional observations suggest that CBs participate in early events of snRNA biogenesis. First, Smith and Lawrence (2000) showed that oligonucleotides complementary to the 3' tails of pre-U2 RNA specifically hybridized to CB-bound RNAs. Curiously, hybridization was detected in all CBs, not just the ones adjacent to *RNU2* loci (Smith and Lawrence, 2000). Second, we noticed that PHAX, the protein involved in export of pre-U2 snRNA, also accumulates in CBs (Fig. 6 C). Similar focal accumulations are observed using anti-PHAX polyclonal antibodies (Segref et al., 2001). The finding that a protein required for export of U snRNAs from the nucleus localizes in the CB is consistent with the idea that factors within CBs (e.g., Sm proteins, U2B'') may bind to nascent or newly released snRNA transcripts.

Interestingly, expression of mutant PHAX-GFP constructs did not perturb U2 snRNP levels within the CB compartment. The apparent lack of dominant-negative effects in mammalian cells contrasts with those observed in *Xenopus* oocytes (Ohno et al., 2000). This is likely due to the fact that the CBC-PHAX interaction in the absence of RNA, exportin1, and RanGTP is very weak (Ohno et al., 2000). Thus, extremely high concentrations of mutant PHAX would be needed in order to compete with the endogenous protein for the CBC. Such high concentrations are possible to achieve by microinjection in oocytes, but apparently not by transient transfection in HeLa cells.

Concluding remarks

The data presented here demonstrate that the U2 snRNA is required for interaction of CBs with *RNU2* loci. However, several observations suggest the need for a reexamination of the literature of Sm snRNP biogenesis. For example, Terns and Dahlberg (1994) and Terns et al. (1995) demonstrated that a TMG-capping activity resides in the nucleus and that m7G-capped precursors of spliceosomal snRNAs, such as pre-U1 and -U2, can be hypermethylated in nuclei if the RNAs are complexed with Sm proteins. Marshallsay and Lüthmann (1994) revealed that, in contrast to the situation in *Xenopus* oocytes, the TMG cap is not required for in vitro nuclear import of U1 and U2 snRNPs in somatic cells. Collectively, these and other studies indicate that, once an snRNA is exported to the cytoplasm, Sm core assembly is required for its import. But what if a fraction of the Sm snRNAs never leave the nucleus? Yu et al. (1998) showed

that there are sufficient quantities of Sm proteins available or exchangeable in *Xenopus* oocyte nuclei to assemble internally modified snRNPs, even in the absence of a TMG cap. Finally, Sleeman and Lamond (1999a) showed that GFP-tagged Sm proteins accumulate in CBs before their delivery to other nuclear locations (e.g., speckles). Although we assumed that these GFP-Sm proteins were complexed with snRNAs (thus implicating CBs in snRNP import), it is possible that some Sm proteins might be imported independently of the RNAs. Such a scenario might explain the presence of SMN in the CB. Or perhaps, CBs are involved in both snRNP import and export. Clearly these will be subjects of future investigation.

Materials and methods

Constructs

The constructs used here were generated by PCR with two sets of primers and two ligation events, introducing the desired restriction enzyme sites. The PCR products were digested with the appropriate enzyme, cutting what would ultimately be the internal site. The two digested products were then ligated. After separation of the ligation products on an agarose gel, the band of interest was isolated. In some cases, the isolated ligation product was amplified by PCR before digestion of the outer sites to enable ligation into the desired vector. All mutations were confirmed by sequencing.

The U2 Δ stemI and U2 Δ stemIV constructs were created using primers that flank U2 snRNA stem-loop I and IV sequences (U2 Δ stemI-for, TTGGGAATTCTCAAGTGTAGTATCTGTTCTTAT; U2 Δ stemI-rev, AGGCGAATTCGCGATGCGCTCGCTTCGCGCCC; U2 Δ stemIV-for, ACGGGAATTC-CCTCCGGGATACAACGT; U2 Δ stemIV-rev, GTCGGAATTCGGAGTGG-ACGGAGCAAGTCTC) in a PCR reaction along with primers to introduce flanking 5' BglII and 3' BamHI/HindIII sites (U2mut-for, CAGGAGATCTAG-GCACAGGGGCTGGGGAGAA; U2mut2-rev, ATTCTAAGCTTACTGACACAGGATCCGAAAACC) using pmU2+CT as a template (Bailey et al., 1995; Frey et al., 1999). After ligation, an internal EcoRI site replaced stem I and IV sequences. After digestion with BglII and HindIII, the product was then cloned into pUC18-Bgl (Bailey et al., 1995; Frey et al., 1999). We multimerized U2 Δ stemI and U2 Δ stemIV in pUC18-Bgl to four copies by taking advantage of the fact that BglII and BamHI can form a hybrid site that neither enzyme can digest. Head-to-tail multimerization was thus achieved by digestion with BglII/HindIII and BamHI/HindIII. Therefore, the BamHI/HindIII fragment serves as the new vector and receives the BglII/HindIII product as insert. After two cloning rounds, four tandem copies were produced.

Replacement+CT was constructed using the method described above. We amplified the 5' portion of Replacement including the 3' end of the adenovirus 2 coding region and joined it via an engineered EcoRI site (U2Ad-for, 5'-CCTTAGATCTCCCTGACTGGGCATGGGCCCTC-3'; U2Ad-rev2, 5'-AGGGGAATTCAGCTTGACAACAAAAGATTGTCTT-3') to the 3' PCR product used to create U2 Δ stemIV. This fragment contains U2 downstream sequences including the U2 3' box and CT repeat. Because the adenovirus sequence contains a HindIII site, a partial digestion was used to clone it via BglII/HindIII into pUC18-Bgl. This insert was not multimerized in the vector before concatamerization due to the internal HindIII site.

The RSV-U2 construct was assembled using pRc/RSV (Invitrogen) and mU2+CT as PCR templates. The internal site used to fuse the RSV promoter to the U2 coding region was the rare cutter, SgfI. We chose SgfI (GCGATCGC) for its similarity to both the transcriptional start site of the RSV promoter and the 5' end of the U2 coding region. A PCR reaction using pRc/RSV as a template produced the RSV promoter flanked by 5' BglII and 3' SgfI sites (pRc/RSV-for, 5'-GGGTATTGTCTCATGAGCGGATACATA-3'; pRc/RSV-Sgf-rev, 5'-GGTGAATGGTGGATCGCGTTATT-GTA-3'). Another PCR reaction using mU2+CT as a template generated the U2 coding region and downstream sequences flanked by 5' SgfI and 3' XbaI sites (U2-Sgf-for, 5'-CGAAGGCGAGCGATCGCTTCTCGGC-3'; U2-Xba-rev, 5'-ACCGTCTCTAGACTCCCTCTACTTTTAGGA-3'). The products were digested, ligated, and cloned into BglII/XbaI digested pRc/RSV. We excised RSV-U2 as a BglII/BamHI fragment and cloned it into pUC18-Bgl for multimerization to four copies as described above.

Assembly and expression of artificial arrays and stable cell lines

Artificial arrays were generated as previously described (Bailey et al., 1995; Frey et al., 1999) with the following modifications. Constructs were digested

with BamHI/BglII and separated on an agarose gel. The desired band was isolated. Array assembly was carried out as described (Bailey et al., 1995). Ligations included a neomycin resistance cassette. A 1% low-melt agarose gel separated differentially sized arrays by field inversion electrophoresis. To enrich for larger arrays, high molecular weight species were excised and the agarose was digested by β -agarase. The product of β -agarase digestion was then directly transfected into pseudo-diploid HT-1080 cells using Lipofectin reagent (Life Technologies). After selection in Geneticin (G418; Life Technologies), colonies were transferred to 96-well plates, replica plated, and then screened by Southern blot. Gene copy number was determined by phosphorimager analysis (Bailey et al., 1995). We determined steady-state expression levels using a primer extension assay previously described (Bailey et al., 1995; Frey et al., 1999). Primer extension products were separated on a 15% denaturing polyacrylamide gel, and RNA ratios were calculated using a phosphorimager (Bailey et al., 1995; Frey et al., 1999).

IF and in situ hybridization

Cells were grown on chambered slides overnight to 50–80% confluency. After permeabilization in ice cold 0.5% Triton X-100/1 \times CSK buffer for 1 min, cells were fixed in 4% paraformaldehyde for 10 min at room temperature. IF and DNA FISH were carried out as described (Frey and Matera, 1995) with an increased cellular DNA denaturation period of 30 min. We performed RNA FISH as described (Frey et al., 1999). Microscopy and imaging were as described previously (Frey and Matera, 1995).

RNA oligo FISH

Hybridization to U2 snRNA was performed using a biotinylated U2 PNA probe (5'-Bio-OO-ACAGACTACTACA-3', where O represents abasic linker). Hybridization solution consisted of 4 \times SSC/10% dextran sulfate and 2 pmoles/ μ l of U2 PNA. After a 37 $^{\circ}$ C hybridization for 30 min and washing in 4 \times SSC/0.1% Tween-20, detection was carried out with fluorescein-conjugated avidin.

Inhibition of snRNA nuclear export

HeLa cells were seeded onto slides and grown overnight to 50–80% confluency. The medium was replaced with fresh medium containing 20 or 30 nM LMB, and cells were incubated for 1, 3, 5, 8, or 14 h. After preextraction in 0.5% Triton X-100/1 \times CSK buffer and fixation in 4% paraformaldehyde, we performed IF and DNA FISH as described above.

Microinjection

HeLa cells were seeded onto glass cover slips and grown overnight to 50–80% confluency. Deoxyoligonucleotides were coinjected into the cytoplasm with lysine-fixable Texas red-conjugated or biotin-conjugated 70-kD dextrans (Molecular Probes). Microinjection buffer consisted of 10 mM NaH₂PO₄, 70 mM KCl, pH 7.2 (O'Keefe et al., 1994). Oligonucleotide and dextran concentrations were 150 μ M and 6 mg/ml, respectively. A random 15-mer and a deoxyoligonucleotide complementary to nucleotides 31–45 of U2 snRNA were used (U2dep, 5'-GAACAGACTACTACAC-3'). Oligomers were then loaded into Femtotips (Eppendorf) and injected into cells using an Eppendorf transjector and micromanipulator. Cells were injected on a heated stage in DME (Life Technologies) containing 20 mM HEPES buffer (pH 7.2). Subsequent to injection, cells were washed three times in DME (without HEPES) and incubated at 37 $^{\circ}$ C for 2 h.

We thank A. Tartakoff for helpful advice and suggestions for experiments. We are also indebted to A. Bailey and A. Weiner for advice on construction of artificial arrays, I. Mattaj (European Molecular Biology Laboratory, Heidelberg, Germany) for PHAX constructs and insightful discussion, as well as E. Chan (The Scripps Institute, La Jolla, CA) and G. Dreyfuss (University of Pennsylvania, Philadelphia, PA) for antibodies.

M.R. Frey was supported by a National Institutes of Health predoctoral traineeship (T32-GM08056) and by a grant from the Muscular Dystrophy Association (to A.G. Matera). This work was also supported by National Institutes of Health grant RO1-GM53034 (to A.G. Matera).

Submitted: 17 May 2001

Revised: 27 June 2001

Accepted: 27 June 2001

References

- Andrade, L.E.C., E.M. Tan, and E.K.L. Chan. 1993. Immunocytochemical analysis of the coiled body in the cell cycle and during cell proliferation. *Proc. Natl. Acad. Sci. USA*. 90:1947–1951.

- Bailey, A., Z. Li, T. Pavelitz, and A. Weiner. 1995. Adenovirus type 12-induced fragility of the human RNU2 locus requires U2 small nuclear RNA transcriptional regulatory elements. *Mol. Cell Biol.* 15:6246–6255.
- Carmo-Fonseca, M., R. Pepperkok, M.T. Carvalho, and A.I. Lamond. 1992. Transcription-dependent colocalization of the U1, U2, U4/U6 and U5 snRNPs in coiled bodies. *J. Cell Biol.* 117:1–14.
- Carmo-Fonseca, M., J. Ferreira, and A.I. Lamond. 1993. Assembly of snRNP-containing coiled bodies is regulated in interphase and mitosis—evidence that the coiled body is a kinetic nuclear structure. *J. Cell Biol.* 120:841–852.
- Carvalho, T., F. Almeida, A. Calapez, M. Lafarga, M.T. Berciano, and M. Carmo-Fonseca. 1999. The spinal muscular atrophy disease gene product, SMN: a link between snRNP biogenesis and the Cajal (coiled) body. *J. Cell Biol.* 147:715–728.
- Casparly, F., and B. Seraphin. 1998. The yeast U2A'/U2B complex is required for pre-spliceosome formation. *EMBO J.* 17:6348–6358.
- Charroux, B., L. Pellizzoni, R.A. Perkinson, A. Shevchenko, M. Mann, and G. Dreyfuss. 1999. Gemin3. A novel dead box protein that interacts with SMN, the spinal muscular atrophy gene product, and is a component of gems. *J. Cell Biol.* 147:1181–1194.
- Cuello, P., D.C. Boyd, M.J. Dye, N.J. Proudfoot, and S. Murphy. 1999. Transcription of the human U2 snRNA genes continues beyond the 3' box in vivo. *EMBO J.* 18:2867–2877.
- Fischer, U., Q. Liu, and G. Dreyfuss. 1997. The SMN-SIP1 complex has an essential role in spliceosomal snRNP biogenesis. *Cell.* 90:1023–1029.
- Frey, M.R., and A.G. Matera. 1995. Coiled bodies contain U7 small nuclear RNA and associate with specific DNA sequences in interphase cells. *Proc. Natl. Acad. Sci. USA.* 92:5915–5919.
- Frey, M.R., A.D. Bailey, A.M. Weiner, and A.G. Matera. 1999. Association of snRNA genes with coiled bodies is mediated by nascent snRNA transcripts. *Curr. Biol.* 9:126–131.
- Gall, J.G. 2000. Cajal bodies: the first 100 years. *Ann. Rev. Cell Dev. Biol.* 16:273–300.
- Gall, J.G., A. Tsvetkov, Z. Wu, and C. Murphy. 1995. Is the sphere organelle/coiled body a universal nuclear component? *Dev. Genet.* 16:25–35.
- Gao, L., M.R. Frey, and A.G. Matera. 1997. Human genes encoding U3 snRNA associate with coiled bodies in interphase cells and are clustered on chromosome 17p11.2 in a complex inverted repeat structure. *Nucleic Acids Res.* 25:4740–4747.
- Hebert, M.D., and A.G. Matera. 2000. Self-association of coilin reveals a common theme in nuclear body localization. *Mol. Biol. Cell.* 11:4159–4171.
- Henry, R., C. Sadowski, R. Kobayashi, and N. Hernandez. 1995. A TBP-TAF complex required for a transcription of human snRNA genes by RNA polymerase II and III. *Nature.* 374:653–656.
- Henry, R.W., E. Ford, R. Mital, V. Mittal, and N. Hernandez. 1998. Crossing the line between RNA polymerases: transcription of human snRNA genes by RNA polymerases II and III. *Cold Spring Harb. Symp. Quant. Biol.* 63:111–120.
- Hernandez, N., and A.M. Weiner. 1986. Formation of the 3' end of U1 snRNA requires compatible snRNA promoter elements. *Cell.* 47:249–258.
- Huang, Q., M.R. Jacobson, and T. Pederson. 1997. 3' processing of human pre-U2 small nuclear RNA: a base-pairing interaction between the 3' extension of the precursor and an internal region. *Mol. Cell Biol.* 17:7178–7185.
- Jacobs, E.Y., M.R. Frey, W. Wu, T.C. Ingledue, T.C. Gebuhr, L. Gao, W.F. Marzluff, and A.G. Matera. 1999. Coiled bodies preferentially associate with U4, U11, and U12 small nuclear RNA genes in interphase HeLa cells but not with U6 and U7 genes. *Mol. Biol. Cell.* 10:1653–1663.
- Kambach, C., and I.W. Mattaj. 1994. Nuclear transport of the U2 snRNP-specific U2B'' protein is mediated by both direct and indirect signalling mechanisms. *J. Cell Sci.* 107:1807–1816.
- Kudo, N., B. Wolff, T. Sekimoto, E.P. Schreiner, Y. Yoneda, M. Yanagida, S. Horinouchi, and M. Yoshida. 1998. Leptomycin B inhibition of signal-mediated nuclear export by direct binding to CRM1. *Exp. Cell Res.* 242:540–547.
- Lewis, J.D., and D. Tollervey. 2000. Like attracts like: getting RNA processing together in the nucleus. *Science.* 288:1385–1389.
- Liu, Q., and G. Dreyfuss. 1996. A novel nuclear structure containing the survival of motor neurons protein. *EMBO J.* 15:3555–3565.
- Mangin, M., M. Ares, and A.M. Weiner. 1986. Human U2 small nuclear RNA genes contain an upstream enhancer. *EMBO J.* 5:987–995.
- Marshall, C., and R. Lührmann. 1994. In vitro nuclear import of snRNPs: cytosolic factors mediate m3G-cap dependence of U1 and U2 snRNP transport. *EMBO J.* 13:222–231.
- Matera, A.G. 1998. Of coiled bodies, gems, and salmon. *J. Cell. Biochem.* 70:181–192.
- Matera, A.G. 1999. Nuclear bodies: multifaceted subdomains of the interchromatin space. *Trends Cell Biol.* 9:302–309.
- Matera, A.G., and M.R. Frey. 1998. Coiled bodies and gems: Janus or Gemini? *Am. J. Hum. Genet.* 63:317–321.
- Matera, A.G., and D.C. Ward. 1993. Nucleoplasmic organization of small nuclear ribonucleoproteins in cultured human cells. *J. Cell Biol.* 121:715–727.
- Meister, G., D. Buhler, B. Laggerbauer, M. Zobawa, F. Lottspeich, and U. Fischer. 2000. Characterization of a nuclear 20S complex containing the survival of motor neurons (SMN) protein and a specific subset of spliceosomal Sm proteins. *Hum. Mol. Genet.* 9:1977–1986.
- O'Keefe, R.T., A. Mayeda, C.L. Sadowski, A.R. Krainer, and D.L. Spector. 1994. Disruption of pre-mRNA splicing in vivo results in reorganization of splicing factors. *J. Cell Biol.* 124:249–260.
- Ohno, M., A. Segref, A. Bachi, M. Wilm, and I.W. Mattaj. 2000. PHAX, a mediator of U snRNA nuclear export whose activity is regulated by phosphorylation. *Cell.* 101:187–198.
- Overbeek, P.A., S.P. Lai, K.R. Van Quill, and H. Westphal. 1986. Tissue-specific expression in transgenic mice of a fused gene containing RSV terminal sequences. *Science.* 231:1574–1577.
- Pan, Z.Q., and C. Prives. 1988. Assembly of functional U1 and U2 human-amphibian hybrid snRNPs in *Xenopus laevis* oocytes. *Science.* 241:1328–1331.
- Pilch, D.R., and W.F. Marzluff. 1991. Expression of histone-U1 snRNA chimeric genes: U1 promoters are compatible with histone 3' end formation. *Gene Expr.* 1:41–53.
- Polycarpou-Schwarz, M., S.I. Gunderson, S. Kandels-Lewis, B. Seraphin, and I.W. Mattaj. 1996. *Drosophila* SNF/D25 combines the functions of the two snRNP proteins U1A and U2B'' that are encoded separately in human, potato, and yeast. *RNA* 2:11–23.
- Schul, W., R. van Driel, and L. de Jong. 1998. Coiled bodies and U2 snRNA genes adjacent to coiled bodies are enriched in factors required for snRNA transcription. *Mol. Biol. Cell.* 9:1025–1036.
- Segref, A., I.W. Mattaj, and M. Ohno. 2001. The evolutionarily conserved region of the U snRNA export mediator PHAX is a novel RNA-binding domain that is essential for U snRNA export. *RNA.* 7:351–360.
- Shopland, L.S., M. Byron, J.L. Stein, J.B. Lian, G.S. Stein, and J.B. Lawrence. 2001. Replication-dependent histone gene expression is related to Cajal body (CB) association but does not require sustained CB contact. *Mol. Biol. Cell.* 12:565–576.
- Sleeman, J.E., and A.I. Lamond. 1999a. Newly assembled snRNPs associate with coiled bodies before speckles, suggesting a nuclear snRNP maturation pathway. *Curr. Biol.* 9:1065–1074.
- Sleeman, J.E., and A.I. Lamond. 1999b. Nuclear organization of pre-mRNA splicing factors. *Curr. Opin. Cell Biol.* 11:372–377.
- Smith, K.P., and J.B. Lawrence. 2000. Interactions of U2 gene loci and their nuclear transcripts with Cajal (coiled) bodies: evidence for PreU2 within Cajal bodies. *Mol. Biol. Cell.* 11:2987–2998.
- Smith, K.P., K. Carter, C. Johnson, and J.B. Lawrence. 1995. U2 and U1 snRNA gene loci associate with coiled bodies. *J. Cell. Biochem.* 59:473–485.
- Terns, M.P., and J.E. Dahlberg. 1994. Retention and 5' cap trimethylation of U3 snRNA in the nucleus. *Science.* 264:959–961.
- Terns, M.P., J.E. Dahlberg, and E. Lund. 1993a. Multiple cis-acting signals for export of pre-U1 snRNA from the nucleus. *Genes Dev.* 7:1898–1908.
- Terns, M.P., E. Lund, and J.E. Dahlberg. 1993b. A pre-export U1 snRNP in *Xenopus laevis* oocyte nuclei. *Nucleic Acids Res.* 21:4569–4573.
- Terns, M.P., C. Grimm, E. Lund, and J.E. Dahlberg. 1995. A common maturation pathway for small nucleolar RNAs. *EMBO J.* 14:4860–4871.
- Wu, J.A., and J.L. Manley. 1991. Base pairing between U2 and U6 snRNAs is necessary for splicing of a mammalian pre-mRNA. *Nature.* 352:818–821.
- Yan, D., and M. Ares. 1996. Invariant U2 RNA sequences bordering the branch-point recognition region are essential for interaction with yeast SF3a and SF3b subunits. *Mol. Cell Biol.* 16:818–828.
- Yoon, J.B., S. Murphy, L. Bai, Z. Wang, and R.G. Roeder. 1995. Proximal sequence element-binding transcription factor (PTF) is a multisubunit complex required for transcription of both RNA polymerase II- and RNA polymerase III-dependent small nuclear RNA genes. *Mol. Cell Biol.* 15:2019–2027.
- Young, P.J., T.T. Le, N. thi Man, A.H. Burghes, and G.E. Morris. 2000. The relationship between SMN, the spinal muscular atrophy protein, and nuclear coiled bodies in differentiated tissues and cultured cells. *Exp. Cell Res.* 256:365–374.
- Yu, Y.T., M.D. Shu, and J.A. Steitz. 1998. Modifications of U2 snRNA are required for snRNP assembly and pre-mRNA splicing. *EMBO J.* 17:5783–5795.
- Zhou, D., D. Frendewey, and S.M. Lobo Ruppert. 1999. Pac1p, an RNase III homolog, is required for formation of the 3' end of U2 snRNA in *Schizosaccharomyces pombe*. *RNA.* 5:1083–1098.