

Bicarbonate and Chloride Secretion in Calu-3 Human Airway Epithelial Cells

Daniel C. Devor, Ashvani K. Singh, Linda C. Lambert, Arthur DeLuca, Raymond A. Frizzell, and Robert J. Bridges

From the Department of Cell Biology and Physiology, University of Pittsburgh, Pittsburgh, Pennsylvania 15261

ABSTRACT Serous cells are the predominant site of cystic fibrosis transmembrane conductance regulator expression in the airways, and they make a significant contribution to the volume, composition, and consistency of the submucosal gland secretions. We have employed the human airway serous cell line Calu-3 as a model system to investigate the mechanisms of serous cell anion secretion. Forskolin-stimulated Calu-3 cells secrete HCO_3^- by a Cl^- -independent, serosal Na^+ -dependent, serosal bumetanide-insensitive, and serosal 4,4'-dinitrostilben-2,2'-disulfonic acid (DNDS)-sensitive, electrogenic mechanism as judged by transepithelial currents, isotopic fluxes, and the results of ion substitution, pharmacology, and pH studies. Similar studies revealed that stimulation of Calu-3 cells with 1-ethyl-2-benzimidazolinone (1-EBIO), an activator of basolateral membrane Ca^{2+} -activated K^+ channels, reduced HCO_3^- secretion and caused the secretion of Cl^- by a bumetanide-sensitive, electrogenic mechanism. Nystatin permeabilization of Calu-3 monolayers demonstrated 1-EBIO activated a charybdotoxin- and clotrimazole-inhibited basolateral membrane K^+ current. Patch-clamp studies confirmed the presence of an intermediate conductance inwardly rectified K^+ channel with this pharmacological profile. We propose that hyperpolarization of the basolateral membrane voltage elicits a switch from HCO_3^- secretion to Cl^- secretion because the uptake of HCO_3^- across the basolateral membrane is mediated by a 4,4'-dinitrostilben-2,2'-disulfonic acid (DNDS)-sensitive $\text{Na}^+:\text{HCO}_3^-$ cotransporter. Since the stoichiometry reported for $\text{Na}^+:\text{HCO}_3^-$ cotransport is 1:2 or 1:3, hyperpolarization of the basolateral membrane potential by 1-EBIO would inhibit HCO_3^- entry and favor the secretion of Cl^- . Therefore, differential regulation of the basolateral membrane K^+ conductance by secretory agonists could provide a means of stimulating HCO_3^- and Cl^- secretion. In this context, cystic fibrosis transmembrane conductance regulator could serve as both a HCO_3^- and a Cl^- channel, mediating the apical membrane exit of either anion depending on basolateral membrane anion entry mechanisms and the driving forces that prevail. If these results with Calu-3 cells accurately reflect the transport properties of native submucosal gland serous cells, then HCO_3^- secretion in the human airways warrants greater attention.

KEY WORDS: submucosal glands • cystic fibrosis • cystic fibrosis transmembrane conductance regulator • sodium bicarbonate cotransporter • serous cells

introduction

The inherited disease cystic fibrosis (CF)¹ is characterized by secretion of a thick viscous mucus that plugs the submucosal glands and small airways. This leads to chronic airway infections and is caused by mutations in the cystic fibrosis transmembrane conductance regulator (CFTR) (Boat et al., 1989). The predominant site of CFTR expression in the human lung is the serous cells of the submucosal glands (Jacquot et al., 1993; Engelhardt et al., 1994). Serous cells account for 60% of the

cellular volume of the submucosal gland in human airways (Basbaum et al., 1990). Stimulation of an isotonic fluid secretion from the serous cells contributes to the hydration of the secretions from the mucous cells, thereby forming the low viscosity mucus that lines the conducting airways. Serous cells are also a major source of antimicrobial enzymes and peptides that help maintain an aseptic environment in the lungs (Basbaum et al., 1990). Salt concentration can influence the activity of these antimicrobial agents and it was recently suggested that altered salt concentration in the airway surface fluid may contribute to chronic airway infection in CF (Smith et al., 1996). Thus, the serous cells make a significant contribution to the volume, composition, and consistency of the submucosal gland secretions and represent a potentially important target in CF therapy. These considerations indicate the importance in understanding the mechanisms of fluid and electrolyte transport by serous cells.

Shen et al. (1994) screened 12 cell lines derived from lung adenocarcinomas in an attempt to identify a cell

Address correspondence to Daniel C. Devor, Ph.D., or Robert J. Bridges, University of Pittsburgh, Department of Cell Biology and Physiology, S312 Biomedical Science Tower, 3500 Terrace Street, Pittsburgh, PA 15261. Fax: 412-648-2844; E-mail: dd2+@pitt.edu or bbridges+@pitt.edu

¹Abbreviations used in this paper: CF, cystic fibrosis; CFTR, cystic fibrosis transmembrane conductance regulator; CTX, charybdotoxin; DNDS, 4,4'-dinitrostilben-2,2'-disulfonic acid; 1-EBIO, 1-ethyl-2-benzimidazolinone; NBC, $\text{Na}^+:\text{HCO}_3^-$ cotransporter; R_T , transepithelial resistance.

line that displayed electrophysiological properties consistent with human airway serous cells. They identified the Calu-3 cell line as being serous cell in nature, forming a monolayer with a transepithelial resistance of $\sim 100 \Omega \cdot \text{cm}^2$, expressing high levels of CFTR and responding to both cAMP- and Ca^{2+} -mediated agonists with changes in net transepithelial ion transport as measured by short circuit current (I_{sc}) (Finkbeiner et al., 1993; Shen et al., 1994). Several studies have produced variable results in the basal and stimulated transport properties of the Calu-3 cells and the ionic basis of the responses to secretory agonists remains unsettled (Shen et al., 1994; Illek et al., 1997; Moon et al., 1997; Singh et al., 1997; Lee et al., 1998). In this report, we present studies with Calu-3 cells that displayed a low basal I_{sc} ($13 \mu\text{A cm}^{-2}$) and robust sustained responses to secretory agonists enabling the measurement of isotopic fluxes. The results demonstrate that Calu-3 cells, when stimulated by forskolin, secrete HCO_3^- by a Cl^- -independent, Na^+ -dependent, 4,4'-dinitrostilben-2,2'-disulfonic acid (DNDS)-sensitive, electrogenic mechanism. Secondly, when stimulated by 1-ethyl-2 benzimidazolone (1-EBIO), an activator of the basolateral membrane Ca^{2+} -activated K^+ channels (K_{Ca}) (Devor et al., 1996), HCO_3^- secretion is reduced and the Calu-3 cells secrete predominately Cl^- by a bumetanide-sensitive, electrogenic mechanism.

methods

Cell Culture

Calu-3 cells were grown in Dulbecco's modified Eagle's medium and Ham's F-12 (1:1) supplemented with 15% fetal bovine serum and 2 mM glutamine. The cells were incubated in a humidified atmosphere containing 5% CO_2 at 37°C . For measurements of short-circuit current (I_{sc}), Calu-3 cells were seeded onto Costar Transwell cell culture inserts (0.33 cm^2) or Snapwell inserts (1.1 cm^2). Both the Transwell and Snapwell inserts were collagen-coated overnight with 0.01% human placenta collagen type VI (Sigma Chemical Co.). On day one, the medium bathing the apical surface was removed to establish an air interface. Apical medium was removed and the cells fed every 48 h. After ~ 7 –14 d, the cells formed a confluent monolayer that held back fluid, thus maintaining an apical air interface. Short circuit current measurements were performed after an additional 14–28 d in culture. Patch-clamp experiments were performed on single cells plated onto glass cover slips 18–48 h before use.

Solutions

For measurements of I_{sc} , the bath solution contained (mM): 120 NaCl, 25 NaHCO_3 , 3.3 KH_2PO_4 , 0.8 K_2HPO_4 , 1.2 MgCl_2 , 1.2 CaCl_2 , and 10 glucose. Mannitol was substituted for glucose in the mucosal solution to eliminate the contribution of Na^+ glucose cotransport to I_{sc} as previously reported by Singh et al. (1997). The pH of this solution was 7.4 when gassed with a mixture of 95% O_2 –5% CO_2 at 37°C . For the Cl^- -free solution, equimolar Na-gluconate replaced NaCl, 1 mM Mg-gluconate replaced MgCl_2 , and 4 mM Ca-gluconate replaced CaCl_2 . Calcium was increased to 4 mM to compensate for the Ca^{2+} buffering ca-

capacity of the gluconate. The HCO_3^- -free buffer consisted of (mM): 145 NaCl, 3.3 KH_2PO_4 , 0.8 K_2HPO_4 , 1.2 MgCl_2 , 1.2 CaCl_2 , 10 HEPES, pH adjusted with NaOH, 10 glucose or mannitol and was gassed with air. For the Na^+ -free Cl^- -free solution, equimolar *N*-methyl-D-glucamine-gluconate replaced NaCl, choline- HCO_3^- replaced NaHCO_3 , 1 mM Mg-gluconate replaced MgCl_2 , and 4 mM Ca-gluconate replaced CaCl_2 . This solution contained 10 μM atropine to block the cholinergic effect of choline (Muallem et al., 1988).

The effects of forskolin and 1-EBIO on apical membrane Cl^- currents (I_{Cl}) were assessed after permeabilization of the serosal membrane with nystatin (360 $\mu\text{g/ml}$), and the establishment of a mucosa-to-serosa Cl^- concentration gradient. Serosal NaCl was replaced by equimolar Na-gluconate and Ca^{2+} was increased to 4 mM with Ca-gluconate. Nystatin was added to the serosal membrane 15–30 min before the addition of drugs. Successful permeabilization of the basolateral membrane was based upon the recording of a current consistent with the mucosal-to-serosal flow of negative charge. The effect of 1-EBIO on basolateral membrane K^+ currents (I_{K}) was assessed after permeabilization of the apical membrane with nystatin (180 $\mu\text{g/ml}$) for 15–30 min, and establishment of a mucosa-to-serosa K^+ concentration gradient. For measurements of I_{K} , mucosal NaCl was replaced by equimolar K-gluconate, while serosal NaCl was substituted with equimolar Na-gluconate. Calcium and Mg^{2+} salts were replaced as above.

During inside-out patch-clamp recordings, the bath contained (mM): 145 K-gluconate, 5 KCl, 1 MgCl_2 , 1 EGTA, 0.78 CaCl_2 , (free $\text{Ca}^{2+} = 400 \text{ nM}$), and 10 HEPES, pH adjusted to 7.2 with KOH. The pipette solution contained (mM): 140 K-gluconate, 5 KCl, 1 CaCl_2 , 1 MgCl_2 , and 10 HEPES, pH adjusted to 7.2 with KOH. For outside-out recordings, the bath contained 1 mM CaCl_2 in the absence of any added EGTA, while the pipette solution Ca^{2+} was buffered to 200 nM with EGTA (0.71 mM Ca^{2+} , 1 mM EGTA).

Short-Circuit Current (I_{sc}) Measurements

Transwell inserts were mounted in an Ussing chamber (Jim's Instruments). Snapwell inserts were mounted in Ussing chambers (NaviCyte), and the monolayers were continuously short-circuited after fluid resistance compensation using automatic voltage clamps (558C-5; Iowa Bioengineering). Transepithelial resistance (R_{T}) was measured by open-circuiting the monolayer, or with a 2-mV bipolar pulse and the resistance calculated by Ohm's law. Forskolin, 1-EBIO, clotrimazole, 293B, and acetazolamide were added to both sides of the monolayers at the indicated concentrations. Bumetanide and charybdotoxin (CTX) were added only to the serosal bathing solution.

Unidirectional Ion Fluxes

20 min after the Snapwell filters were mounted in Ussing chambers, isotopes (^{36}Cl , ^{22}Na , or ^{86}Rb) were added to the bath solution on one side of the monolayers. After an additional 20 min, by which time isotopic fluxes had reached a steady state, two 0.4-ml samples were taken from the unlabeled side and fresh unlabeled solution of equal volume was added. This time was considered time = 0 (T_0), and samples were taken thereafter at 15-min intervals for the next 75 min. When the effects of forskolin, 1-EBIO, or forskolin plus 1-EBIO were studied, the drugs were added to the serosal and mucosal sides at T_{30} and fluxes before ($T_0 - T_{30}$) and 15 min after the drug additions ($T_{45} - T_{75}$) were compared. Isotope activities were determined in a Packard liquid scintillation counter. All samples were weighed and these volumes were used to correct the chamber volume and to calculate the unidirectional ion fluxes using standard equations (Bridges et al., 1983). The net residual ion flux ($J_{\text{net}}^{\text{res}}$) was calculated from

the difference in I_{sc} and the net fluxes of Cl^- , J_{net}^{Cl} ; Na^+ , J_{net}^{Na} ; and Rb^+ , J_{net}^{Rb} , where $J_{net}^R = I_{sc} - (J_{net}^{Na} + J_{net}^{Rb} - J_{net}^{Cl})$.

Single Channel Recording

Single channel currents were recorded in the inside-out and outside-out patch-clamp recording configuration using a List EPC-7 amplifier (Medical Systems) and recorded on videotape for later analysis as described previously (Devor and Frizzell, 1993). Pipettes were fabricated from KG-12 glass (Willmad Glass Co.). All recordings were done at a holding voltage of -100 mV. The voltage is referenced to the extracellular compartment as the standard method for membrane potentials. Inward currents are defined as the movement of positive charge from the extracellular compartment to the intracellular compartment, and are presented as downward deflections from baseline in all recording configurations.

Single channel analysis was performed on records sampled after low-pass filtering at 400 Hz. Data records for all experimental conditions were at least 60-s long. The nP_o (the product of the number of channels, n , and the channel open probability, P_o) of the channels was determined using Biopatch software (3.11; Molecular Kinetics). nP_o was calculated from the mean total current (I) divided by the single channel current amplitude (i), such that $nP_o = I/i$. i was determined from the amplitude histogram of the current record.

Chemicals

Nystatin was a generous gift from Dr. S. Lucania (Bristol Meyers-Squibb). 293B (trans-6-cyano-4-(*N*-ethylsulfonyl-*N*-methylamino)-3-hydroxy-2,2-dimethyl-chroman) was a generous gift from Dr. Rainer Greger (Albert-Ludwigs-Universität, Freiberg, Germany). 1-EBIO was obtained from Aldrich Chemical Co. Acetazolamide, clotrimazole, and bumetanide were obtained from Sigma Chemical Co. Forskolin was obtained from Calbiochem. DNDS was from Pfaltz and Bauer. Charybdotoxin was obtained from Accurate Chemical and Scientific Corp. and made as a $10 \mu M$ stock solution in standard bath solution. 1-EBIO, 293B, and clotrimazole were made as $>1,000$ -fold stock solutions in DMSO. Nystatin was made as a 180 mg/ml stock solution in DMSO and sonicated for 30 s just before use. Forskolin and bumetanide were made as $1,000$ -fold stock solutions in ethanol. Cell culture medium was obtained from GIBCO BRL.

Data Analysis

All data are presented as means \pm SEM, where n indicates the number of experiments.

results

Effects of Forskolin on I_{sc}

In total, we evaluated 216 filters with standard bath solutions on the mucosal and serosal membrane surfaces. The basal I_{sc} and R_T under these conditions averaged $13 \pm 0.8 \mu A \cdot cm^{-2}$ (range 2 – $21 \mu A \cdot cm^{-2}$) and $353 \pm 14 \Omega cm^2$ (range 187 – $667 \Omega cm^2$), respectively. Forskolin (2 – $10 \mu M$) induced, in all filters tested ($n = 109$), a damped oscillatory response that became stable and sustained after 5 – 10 min at a plateau value of $66 \pm 4 \mu A \cdot cm^{-2}$ (range 50 – $103 \mu A \cdot cm^{-2}$). A representative current trace is shown in Fig. 1 A. The increase in I_{sc} caused by forskolin was accompanied by a decrease in

R_T to an average of $189 \pm 7 \Omega cm^{-2}$ (range 111 – $333 \Omega cm^{-2}$). Bumetanide ($20 \mu M$), an inhibitor of the NaK2Cl cotransporter, caused only a small inhibition of the forskolin-stimulated I_{sc} ($\Delta -4.9 \pm 1.3 \mu A \cdot cm^{-2}$, $n = 11$). The failure of bumetanide to inhibit the forskolin-stimulated increase in I_{sc} suggests that the NaK2Cl cotransporter does not contribute to the I_{sc} , and this raised the question whether the I_{sc} was due to Cl^- secretion. Additional experiments were performed to establish the ionic basis of the forskolin-stimulated I_{sc} .

Effects of Forskolin on Isotopic Fluxes

To help elucidate the ionic basis of the forskolin-induced increase in I_{sc} , we performed unidirectional ion flux measurements with ^{36}Cl , ^{22}Na , or ^{86}Rb ; the latter was used as a measure of K^+ movements. The Cl^- flux studies are shown in Fig. 1 B and are summarized together with Na^+ and Rb^+ fluxes in Table I. As in the previous experiments, there was a small basal I_{sc} under control conditions of $\sim 8 \mu A \cdot cm^{-2}$ (i.e., $0.3 \mu Eq \cdot cm^{-2} \cdot h^{-1}$) that was stimulated 6–10-fold by forskolin in the subset of 36 filters used for the flux studies. Under control conditions, there was no net movement of Cl^- or Rb^+ and a small net absorption of Na^+ . Forskolin increased both unidirectional fluxes of Cl^- four- to fivefold (Fig. 1 B). Both Rb^+ fluxes were increased 1.5-fold, but forskolin had no effect on the fluxes of Na^+ (Table I). Because both unidirectional fluxes of Cl^- and Rb^+ were increased to a similar extent, there was no net flux of Cl^- or Rb^+ caused by forskolin. The difference between I_{sc} and the net flux of each ion was calculated and is given in Table I as J_{net}^R . Because there was no net flux of Cl^- or Rb^+ under control or forskolin conditions, neither of these ions account for the basal or forskolin-stimulated I_{sc} . However, the net absorption of Na^+ fully accounts for the control, basal I_{sc} , and a small portion (15%) of the I_{sc} in the forskolin-stimulated cells. When the flux studies for Cl^- , Na^+ , and Rb^+ were combined to calculate the J_{net}^R using the mean I_{sc} (control $0.31 \pm 0.053 \mu Eq \cdot cm^{-2} \cdot h^{-1}$; forskolin $2.60 \pm 0.144 \mu Eq \cdot cm^{-2} \cdot h^{-1}$, $n = 36$) for the studies in Table I, the control J_{net}^R was $-0.12 \pm 0.11 \mu Eq \cdot cm^{-2} \cdot h^{-1}$ and the forskolin J_{net}^R was $2.37 \pm 0.189 \mu Eq \cdot cm^{-2} \cdot h^{-1}$. These results demonstrate that the forskolin-induced increase in I_{sc} cannot be accounted for by the net transepithelial secretion of Cl^- or the absorption of Na^+ or K^+ . Rather, the increase in I_{sc} caused by forskolin must be attributed to the net movement of an unmeasured ion, often referred to as the net residual ion flux, J_{net}^R . Because HCO_3^- is the only remaining ion of significant concentration, J_{net}^R is likely to be due to the net secretion of HCO_3^- and additional experiments were performed to test this hypothesis.

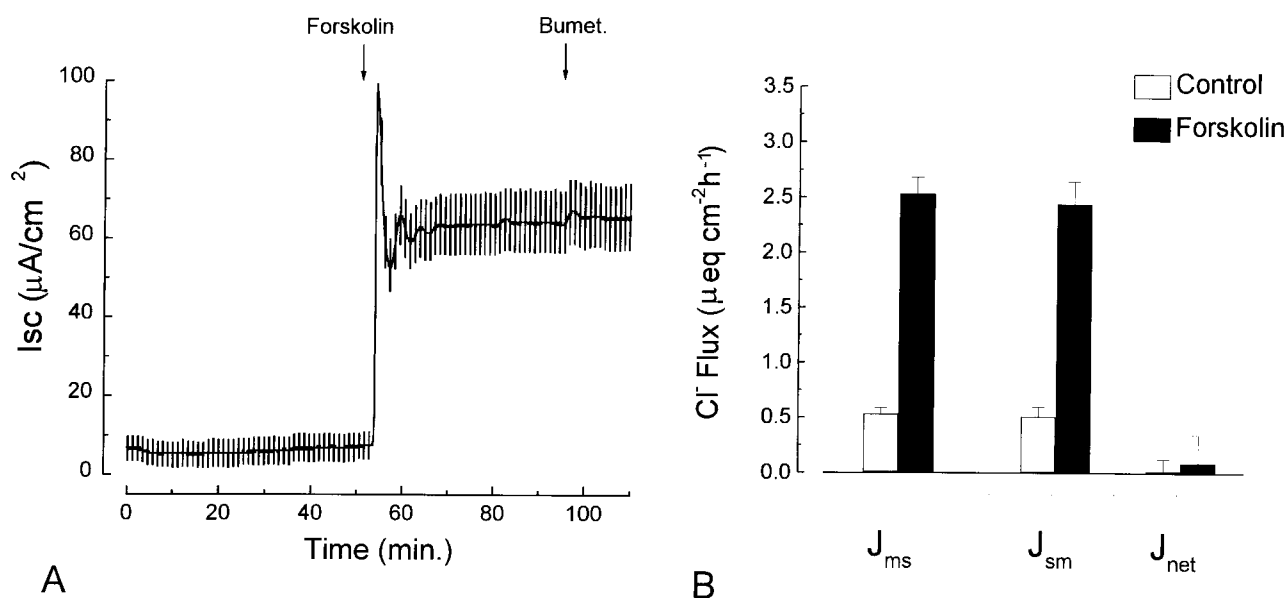

FIGURE 1. Effects of forskolin on Calu-3 cell I_{sc} and Cl^- fluxes. (A) Short circuit current trace demonstrating the increase in I_{sc} in response to forskolin ($2 \mu M$) and the failure of bumetanide ($20 \mu M$) to inhibit forskolin-stimulated I_{sc} . Current deflections are the response to ± 2 -mV pulses. (B) Unidirectional and net fluxes of Cl^- are shown for time periods before and after the addition of forskolin. Note the fivefold increase in both the mucosal-to-serosal flux (J_{ms}) and the serosal-to-mucosal flux (J_{sm}) caused by forskolin and the lack of a net flux (J_{net}) of Cl^- . Fluxes are plotted as the absolute values and are also summarized in Table I.

Ion Substitution Studies

Ion substitution experiments were performed to help further establish the ionic basis of the forskolin-stimulated I_{sc} . Consistent with the failure of bumetanide to inhibit the forskolin-stimulated I_{sc} and the J_{net}^{Cl} of only $0.09 \pm 0.257 \mu Eq \cdot cm^{-2} \cdot h^{-1}$, substitution of Cl^- with gluconate caused only a partial reduction of the response to forskolin (Fig. 2 A). Similar to the control response, the I_{sc} response to forskolin in Cl^- -free solution was rapid in onset with a transient peak and a sustained plateau of $46 \pm 1.6 \mu A \cdot cm^{-2}$ ($n = 24$) (Fig. 2 A). The subsequent addition of Cl^- (30–60 mM) to the

mucosal or serosal solution did not cause a further increase in I_{sc} (data not shown). As in the Cl^- containing solution, bumetanide ($20 \mu M$ serosal) had no effect on the forskolin-stimulated I_{sc} ($\Delta 0.15 \pm 0.76 \mu A \cdot cm^{-2}$, $n = 6$) (Fig. 3). In contrast, removal of HCO_3^- from the mucosal and serosal bathing solutions resulted in a greatly diminished response to forskolin (Fig. 2 B). After a transient response, I_{sc} was increased by only $4 \pm 1 \mu A \cdot cm^{-2}$ ($n = 10$) in HCO_3^- -free solutions. Substitution of Na^+ with *N*-methyl-D-glucamine, Cl^- with gluconate, and $NaHCO_3$ with choline HCO_3 also resulted in a greatly reduced response to forskolin. Forskolin

table i
Effects of Forskolin on Unidirectional and Net Ion Fluxes Across Calu-3 Cell Monolayers

	J_{ms}	J_{sm}	J_{net}	I_{sc}	R_T	J_{net}^R
Chloride Fluxes						
Control	0.53 ± 0.059	0.51 ± 0.091	$+0.02 \pm 0.108$	0.27 ± 0.045	339 ± 24	0.29 ± 0.117
Forskolin	2.53 ± 0.151	2.44 ± 0.208	$+0.09 \pm 0.257$	2.55 ± 0.109	202 ± 14	2.64 ± 0.279
Sodium Fluxes						
Control	2.27 ± 0.154	1.81 ± 0.184	$+0.46 \pm 0.239$	0.37 ± 0.074	294 ± 21	0.09 ± 0.250
Forskolin	2.22 ± 0.205	1.89 ± 0.211	$+0.33 \pm 0.294$	2.36 ± 0.186	154 ± 17	2.03 ± 0.347
Rubidium Fluxes						
Control	0.03 ± 0.005	0.04 ± 0.003	-0.01 ± 0.020	0.29 ± 0.03	454 ± 27	0.30 ± 0.036
Forskolin	0.05 ± 0.008	0.06 ± 0.005	-0.01 ± 0.006	2.9 ± 0.128	190 ± 10	2.91 ± 0.129

Flux values and I_{sc} are in $\mu eq \cdot cm^{-2} \cdot h^{-1}$, and resistance (R_T) in Ωcm^2 . Measurements were made before and after the addition of forskolin ($2 \mu M$) to the mucosal (m) and serosal (s) solutions. Values are the mean \pm SEM, $n = 6$ for each unidirectional flux and 12 for J_{net} , I_{sc} , R_T , and J_{net}^R . See text for explanation of J_{net}^R .

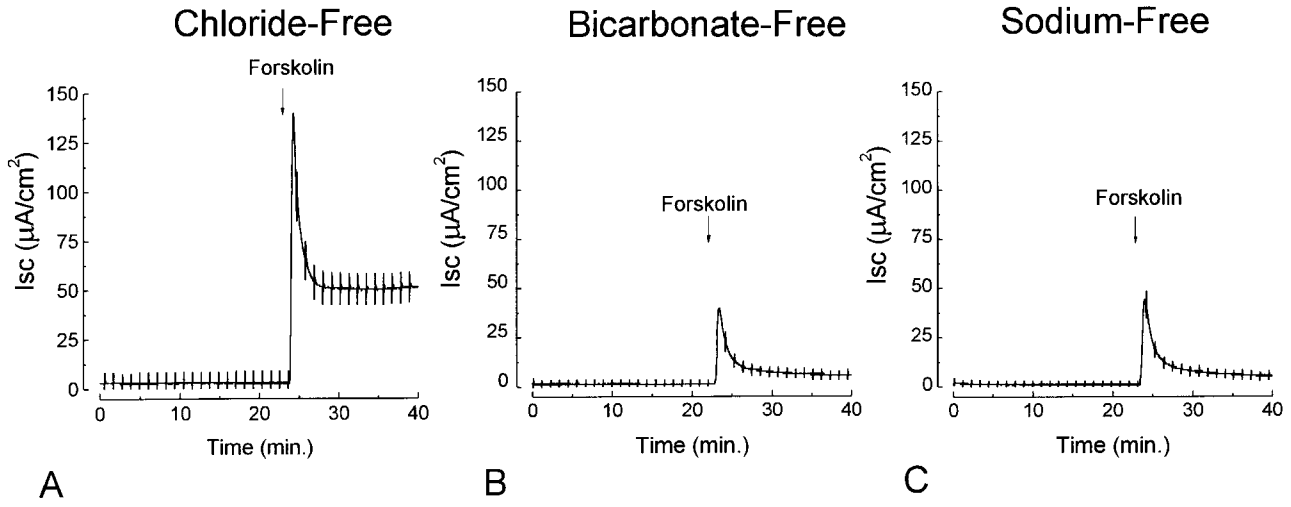

FIGURE 2. Forskolin effects on Calu-3 cell I_{sc} in nominally Cl^- -free (A), HCO_3^- -free (B), or Na^+ -free (C) buffers. Note the lack of a sustained forskolin ($2 \mu M$)-stimulated increase in I_{sc} in the HCO_3^- -free and Na^+ -free buffers. Current traces are representative of 12–24 experiments with similar results.

caused a transient increase in I_{sc} without a sustained plateau in the Na^+ -free, Cl^- -free, HCO_3^- -containing solution (Fig. 2 C), which resembles the response in HCO_3^- -free media. However, the subsequent addition of Na^+ (30 mM) to the serosal but not the mucosal solution caused a sustained increase in I_{sc} of $24 \pm 1.0 \mu A \cdot cm^{-2}$ ($n = 12$) in forskolin-stimulated cells (Fig. 4). Addition of Na^+ (30 mM) to the serosal solution before forskolin caused a small decrease in I_{sc} $\Delta -7.6 \pm 0.2 \mu A \cdot cm^{-2}$ ($n = 12$) as expected for the serosal-

to-mucosal diffusion of a cation. This decrease in I_{sc} was reversed and I_{sc} rose to a sustained level of $23 \pm 0.8 \mu A \cdot cm^{-2}$ ($n = 12$) with the subsequent addition of forskolin. Thus, the forskolin-stimulated increase in the I_{sc} was Cl^- independent but Na^+ and HCO_3^- dependent.

Pharmacology Studies

The above results are consistent with forskolin-stimulated net secretion of HCO_3^- . To further test this hy-

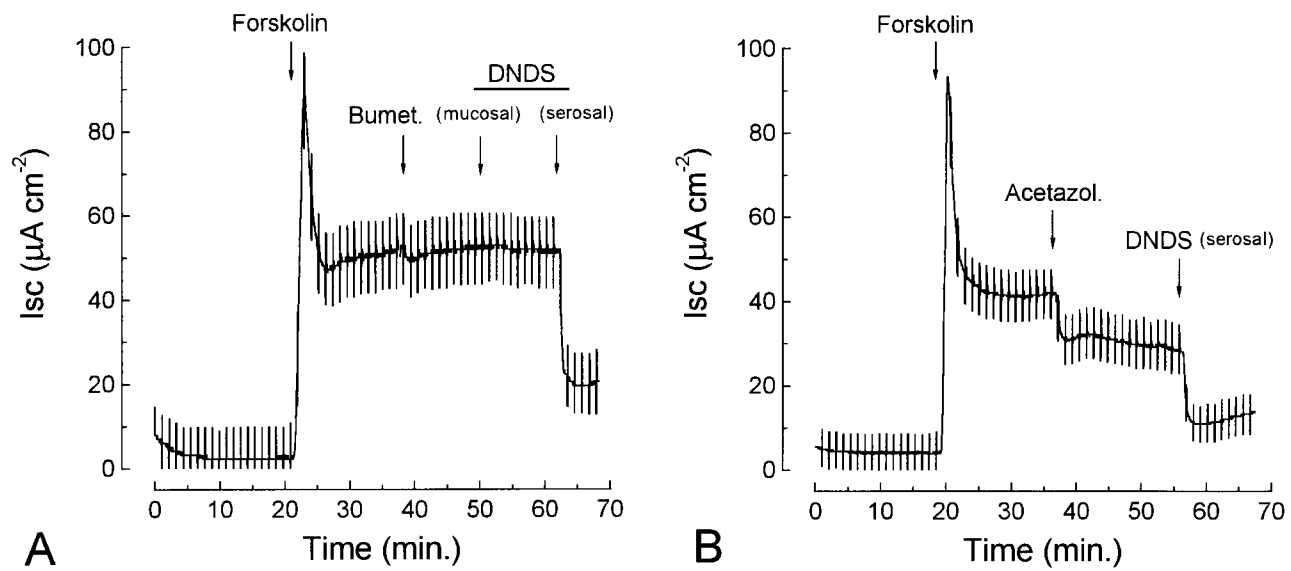

FIGURE 3. Effects of bumetanide, DNDS, and acetazolamide on forskolin-stimulated Calu-3 cell I_{sc} in Cl^- -free buffers. (A) Bumetanide ($20 \mu M$) and mucosal DNDS ($3 mM$) failed to inhibit the forskolin-stimulated I_{sc} that was inhibited by serosal DNDS. (B) Acetazolamide ($100 \mu M$) caused a partial inhibition of the forskolin response that was further inhibited by serosal DNDS. Current traces are representative of 6–12 experiments with similar results.

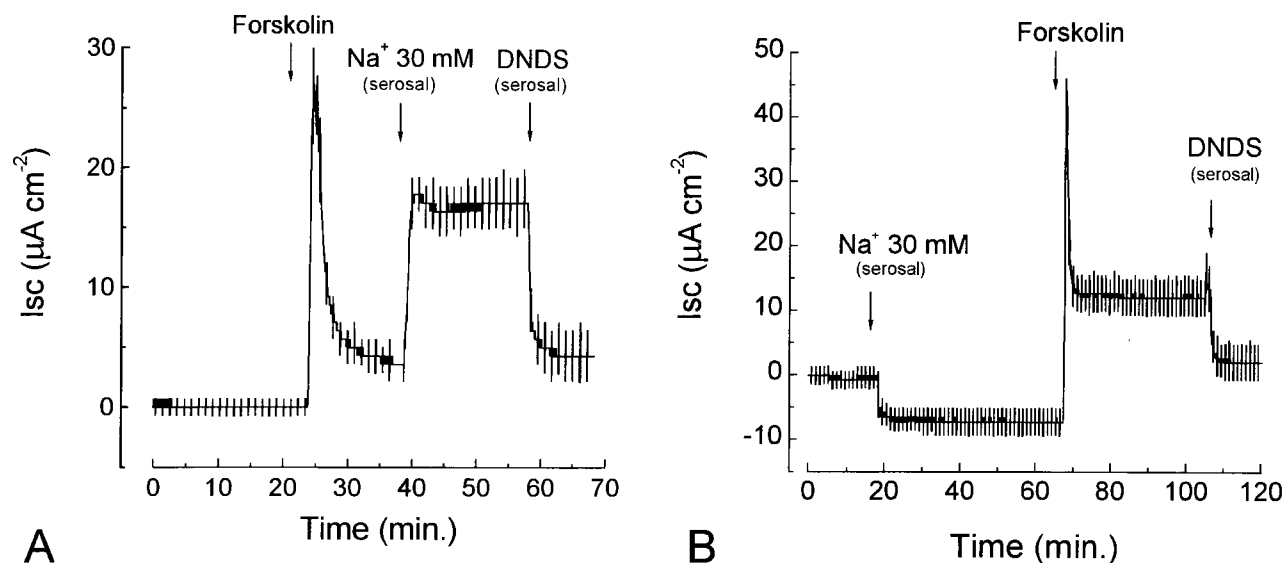

FIGURE 4. Sodium dependence of the forskolin-stimulated I_{sc} in Calu-3 cells. Calu-3 cells were short-circuited in an *N*-methyl-D-glucamine gluconate, choline HCO_3^- buffer. Cells were stimulated with forskolin ($2 \mu M$) either before (A) or after (B) the addition of 30 mM Na-gluconate to the serosal solution. Note that forskolin failed to cause a sustained increase in I_{sc} in the absence of serosal Na. Mucosal Na (30 mM) had no effect on the forskolin-stimulated I_{sc} . Current traces are representative of 6–12 experiments with similar results.

pothesis, the pharmacological sensitivity to various inhibitors of HCO_3^- transport were evaluated. The carbonic anhydrase inhibitor, acetazolamide (1 mM mucosal and serosal), caused a 27% decrease (a reduction of $13 \pm 1 \mu A \cdot cm^{-2}$, $n = 6$) in the forskolin-stimulated I_{sc} in Cl^- -free solutions (Fig. 3). DNDS (3 mM), an inhibitor of Cl^-/HCO_3^- exchangers and Na^+/HCO_3^- cotransporters, was without effect when added to the mucosal solution ($\Delta = 0.2 \mu A \cdot cm^{-2}$, $n = 6$), but caused an inhibition of 56% ($\Delta -26 \pm 1 \mu A \cdot cm^{-2}$, $n = 6$) when added to the serosal side in Cl^- -free solutions. Similar results were obtained in Cl^- -containing solutions ($\Delta -2.5 \pm 1.3 \mu A \cdot cm^{-2}$, $n = 6$ mucosal; $\Delta -27 \pm 2 \mu A \cdot cm^{-2}$, $n = 6$ serosal). The half maximal inhibitory concentration (K_i) for serosal DNDS was 300 μM . The inhibitory effects of serosal DNDS and acetazolamide were additive, together causing a 75% decrease in I_{sc} . The Na^+-K^+ -ATPase inhibitor, ouabain (100 μM), caused an immediate and complete inhibition of the forskolin-stimulated I_{sc} . Neither CTX (50 nM), a blocker of Ca^{2+} activated K^+ channels (Garcia et al., 1995), nor 293B (100 μM), a blocker of the cAMP/PKA activated K^+ channel (KvLQT1; Lohrmann et al., 1995; Loussouarn et al., 1997) inhibited the forskolin-stimulated I_{sc} . The nonselective K^+ channel blocker, Ba^{2+} (5 mM serosal side), inhibited the forskolin-stimulated I_{sc} by only $10 \pm 2 \mu A \cdot cm^{-2}$ ($n = 6$).

The requirement for serosal Na^+ , the inhibition by ouabain, and the partial inhibition by serosal DNDS suggests some of the secreted HCO_3^- is mediated by the

uptake of HCO_3^- across the basolateral membrane on a $Na^+:HCO_3^-$ cotransporter.² The partial inhibition of I_{sc} by acetazolamide suggests some of the secreted HCO_3^- originates from a metabolic source. The Cl^- independence and the failure of mucosal DNDS to inhibit I_{sc} suggests the exit of HCO_3^- across the apical membrane is not mediated by a Cl^-/HCO_3^- exchanger.

pH Studies

The above results are consistent with the conclusion that forskolin stimulation causes the electrogenic secretion of HCO_3^- . To further test this hypothesis, we performed experiments to determine whether forskolin caused an alkalization of the apical solution. Calu-3 cells were studied under open circuit conditions with a small volume of fluid (100 μl) on the apical surface (1.1 cm^2) and 5 ml of continuously gassed (95% $O_2/5\% CO_2$) NaCl, $NaHCO_3$ buffer, pH 7.4, on the serosal side. Cells were incubated without or with forskolin (2 μM) and the apical solution collected after 90 min. The apical sample was thoroughly gassed before mea-

²White (1989) has reported a complete inhibition by 1 mM DNDS of a $Na^+:HCO_3^-$ cotransporter in the basolateral membrane of salamander intestine. Newman (1991) has reported a 73% inhibition by 2 mM DNDS of a $Na^+:HCO_3^-$ cotransporter in retinal glial cells of the salamander. Although perhaps not directly comparable, Boron and Knakal (1989) reported a DNDS K_i of 300 μM of a Na^+ - and Cl^- -dependent HCO_3^- cotransporter in the squid axon.

asuring its pH with a miniature pH electrode. Studied in this manner, we found forskolin caused an alkalinization of the apical solution to a pH of 7.8 ± 0.06 ($n = 6$), whereas control untreated filters showed a small acidification of the apical solution, pH 7.3 ± 0.05 ($n = 6$). The forskolin-stimulated alkalinization of $\Delta 0.5$ pH over a 90-min period corresponds to the net movement of HCO_3^- of $1.7 \mu\text{eq} \cdot \text{cm}^{-2} \cdot \text{h}^{-1}$ or $46 \mu\text{A} \cdot \text{cm}^{-2}$, a value in good agreement with the forskolin-stimulated increase in I_{sc} of $53 \mu\text{A} \cdot \text{cm}^{-2}$ under short circuit conditions.³ Based on these pH measurements, the ion flux measurements, the ion substitution studies, and the pharmacology studies, we conclude that the forskolin-induced I_{sc} response in Calu-3 cells is due to the net secretion of HCO_3^- by a Cl^- -independent Na^+ -dependent, and DNDS-sensitive electrogenic mechanism.

Effects of 1-EBIO on Calu-3 Cells

We previously demonstrated that the novel benzimidazolinone, 1-EBIO, induced a sustained transepithelial Cl^- secretory response in rat colonic mucosa, human colonic T84 cells, and murine airway epithelia (Devor et

al., 1996). CTX and clotrimazole inhibited the 1-EBIO-stimulated Cl^- secretion consistent with the activation of basolateral membrane K^+ channels that was confirmed in permeabilized monolayers (Devor et al., 1996, 1997). Moreover, patch clamp studies demonstrated 1-EBIO activates an inwardly rectifying, calcium activated, CTX, and clotrimazole-sensitive K^+ channel (Devor et al., 1996, 1997). Permeabilized monolayers revealed 1-EBIO also activates an apical membrane Cl^- conductance (Devor et al., 1996). The studies reported here were performed to determine if 1-EBIO would have similar effects on Calu-3 cells.

In 46 experiments, 1-EBIO (1 mM) increased I_{sc} from a basal value of 8 ± 0.8 to $62 \pm 4 \mu\text{A} \cdot \text{cm}^{-2}$ with only a modest decrease in R_T (control $397 \pm 21 \Omega\text{cm}^2$ vs. 1-EBIO $336 \pm 20 \Omega\text{cm}^2$). A current trace of a typical I_{sc} response to 1-EBIO is shown in Fig. 5 A. The response was rapid in onset and sustained over a long period. Dose-response studies revealed the half maximal effective concentration of 1-EBIO was $\sim 500 \mu\text{M}$. Consistent with the activation of the K_{Ca} channels, CTX (50 nM) inhibited 47% of the 1-EBIO-stimulated I_{sc} . The half maximal effective concentration of CTX was 3.2 nM ($n = 4$). Clotrimazole (10 μM), a nonpeptide inhibitor of K_{Ca} , also inhibited $87.6 \pm 1.9\%$ ($n = 5$) of the response to 1-EBIO with a K_i of 1.2 μM ($n = 5$). Bumetanide (20 μM) inhibited $\sim 50\%$ of the 1-EBIO-stimulated I_{sc} (Table II). DNDS and acetazolamide caused only small ($<10\%$) decreases in the 1-EBIO-stimulated I_{sc} .

Unidirectional fluxes of ^{36}Cl revealed that 1-EBIO caused the net secretion of Cl^- (Fig. 5 B and Table II). As in previous experiments (Fig. 1 B), there was no net

³ The net secretion of HCO_3^- can be calculated from the equation J ($\text{mol} \cdot \text{cm}^{-2} \cdot \text{h}^{-1}$) = buffer capacity (β_{CO_2}) $\cdot \Delta\text{pH} \cdot \text{h}^{-1} \cdot \text{volume} \cdot \text{area}^{-1}$, where $\beta_{\text{CO}_2} = 2.3$ (25 mM HCO_3^-), final volume = 100 μl , and area = 1.1 cm^2 . Thus, $J_{\text{HCO}_3^-} = 57.5 \cdot 0.33 \Delta\text{pH} \cdot \text{h}^{-1} \cdot 0.1 \times 10^{-3}$ liters $\cdot 1.1 \text{cm}^{-2} = 1.7 \mu\text{eq} \cdot \text{cm}^{-2} \cdot \text{h}^{-1}$. Although the final volume was not measured, it was consistently greater in the forskolin-stimulated monolayers compared with the control monolayers. Therefore, the actual net flux of HCO_3^- would be proportionally higher and be in even closer agreement with the forskolin-stimulated increase in I_{sc} .

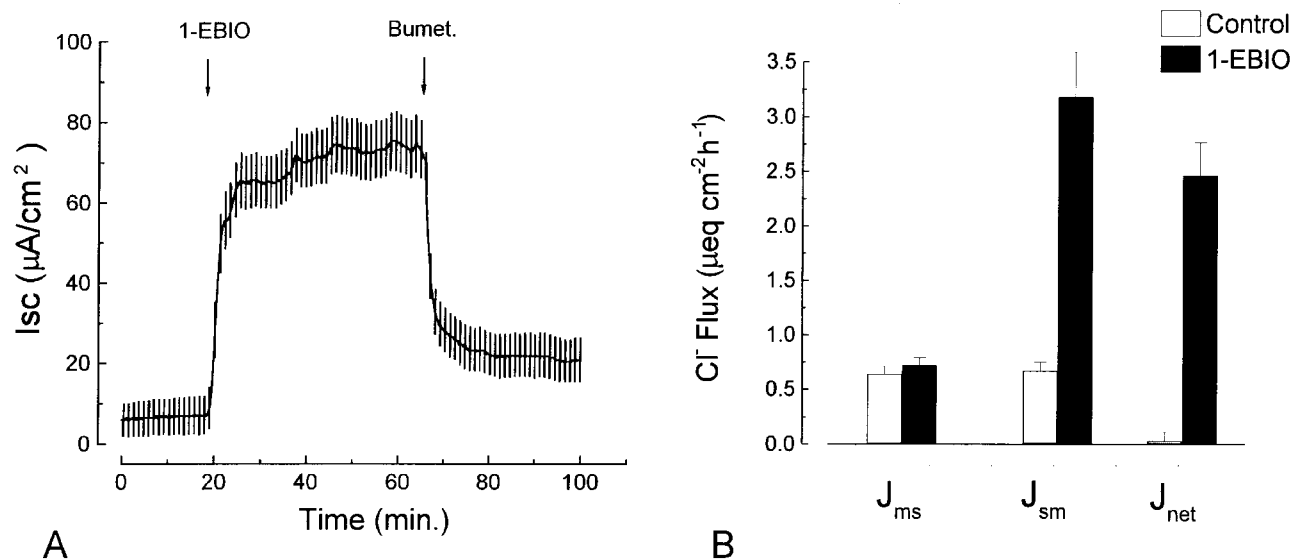

FIGURE 5. Effects of 1-EBIO and bumetanide on Calu-3 cells I_{sc} and Cl^- fluxes. (A) short-circuit current trace demonstrating the increase in I_{sc} in response to 1-EBIO (1 mM) and the inhibition by bumetanide (20 μM). (B) Unidirectional and net ion fluxes of Cl^- are shown for time periods before and after the addition of 1-EBIO. Note that 1-EBIO caused a sixfold increase in J_{sm} , no change in J_{ms} , and a net secretion of Cl^- that, as summarized in Table II, was nearly equal to the increase in I_{sc} . The 1-EBIO-stimulated secretion of Cl^- was inhibited by bumetanide (Table II), as anticipated from the inhibition in I_{sc} . Fluxes are plotted as the absolute values.

table ii

Effects of 1-EBIO and Bumetanide on Unidirectional and Net Cl⁻ Fluxes Across Calu-3 Cell Monolayers

	J_{ms}^{Cl}	J_{sm}^{Cl}	J_{net}^{Cl}	I_{sc}	R_T	J_{net}^R
Control	0.64 ± 0.07	0.67 ± 0.085	-0.03 ± 0.081	0.40 ± 0.061	388 ± 21	0.37 ± 0.072
1-EBIO	0.72 ± 0.068	3.18 ± 0.411	-2.46 ± 0.305	2.71 ± 0.213	273 ± 14	0.25 ± 0.263
Bumetanide	0.59 ± 0.150	1.33 ± 0.054	-0.74 ± 0.109	1.25 ± 0.058	280 ± 17	0.51 ± 0.987

Units are as given in Table I. Measurements were made before and after the addition of 1-EBIO (1 mM) to the mucosal (m) and serosal (s) solutions and bumetanide (20 μ M) to the serosal solution. Values are the mean \pm SEM, $n = 6$ for each unidirectional flux and 12 for J_{net} , I_{sc} , R_T , and J_{net}^R .

secretion of Cl⁻ in control monolayers. 1-EBIO caused a sixfold increase in the serosal-to-mucosal flux of Cl⁻ without altering the mucosal-to-serosal flux leading to net Cl⁻ secretion. Moreover, the net secretion of Cl⁻ fully accounted for the increase in I_{sc} caused by 1-EBIO, leaving a small J_{net}^R of only $0.25 \pm 0.263 \mu\text{Eq} \cdot \text{cm}^{-2} \cdot \text{h}^{-1}$. Bumetanide inhibited the serosal-to-mucosal flux of Cl⁻ and thereby caused a 70% inhibition in J_{net}^{Cl} in 1-EBIO-stimulated monolayers.

Effects of Forskolin and 1-EBIO on I_{sc}

The above results demonstrate Calu-3 cells secrete HCO₃⁻ when stimulated by forskolin and Cl⁻ when stimulated by 1-EBIO. In the next series of experiments, we evaluated the effects of 1-EBIO on forskolin stimulated monolayers. As in the previous experiments, forskolin increased I_{sc} from a control value of 6.8 ± 0.7 to $67 \pm 4.3 \mu\text{A} \cdot \text{cm}^{-2}$ ($n = 12$) without causing the net

secretion of Cl⁻ and leaving a J_{net}^R nearly equal to the change in I_{sc} (Fig. 6 and Table III). 1-EBIO further increased I_{sc} to $114 \pm 5 \mu\text{A} \cdot \text{cm}^{-2}$ (Fig. 6 and Table III). Similar results were obtained if the order of the addition of forskolin and 1-EBIO were reversed. CTX inhibited $79 \pm 2\%$ ($n = 8$) and bumetanide inhibited $80 \pm 1\%$ ($n = 5$) of the forskolin plus 1-EBIO-stimulated I_{sc} . When added to the forskolin-stimulated cells, 1-EBIO caused a twofold increase in the serosal-to-mucosal flux of Cl⁻ and a J_{net}^{Cl} that was nearly equal to the I_{sc} (Fig. 6 and Table III). Thus, 1-EBIO caused a 70% decrease in the forskolin-stimulated J_{net}^R . These results suggest 1-EBIO can switch the forskolin-stimulated Calu-3 cells from HCO₃⁻ to Cl⁻-secreting cells.

One hypothesis to explain the effects of 1-EBIO on Calu-3 cells is the activation of basolateral membrane K⁺ channels that would tend to hyperpolarize the membrane potential. The inhibition of the 1-EBIO response by CTX and clotrimazole support this hypothe-

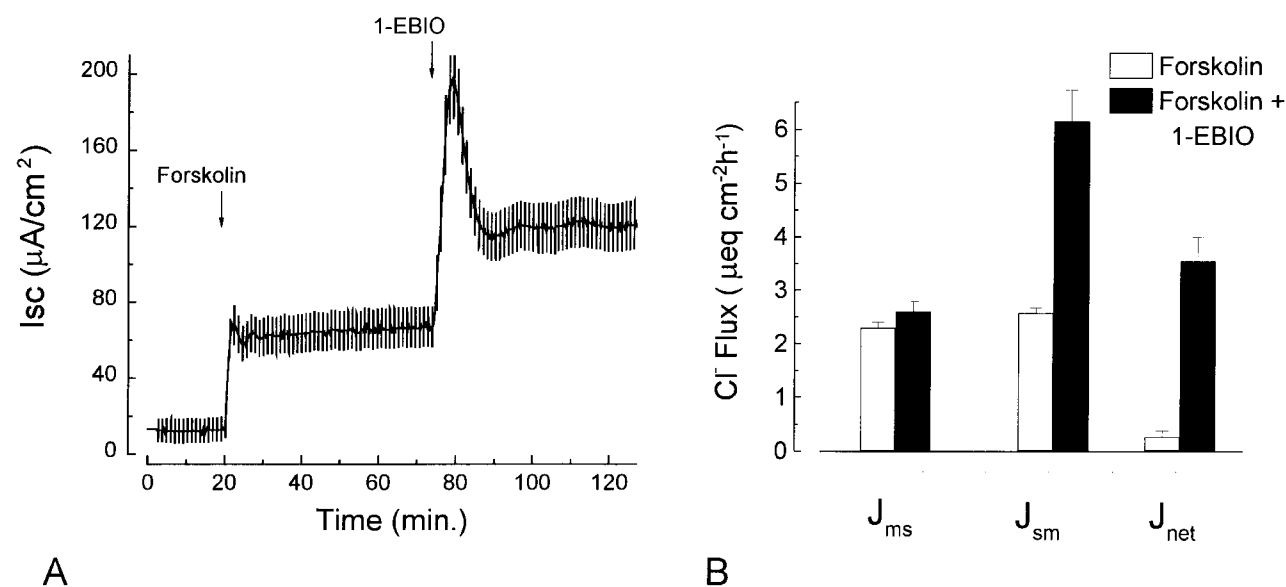

FIGURE 6. Effects of forskolin and 1-EBIO on Calu-3 cell I_{sc} and Cl⁻ fluxes. (A) Short-circuit current trace demonstrating the increase in I_{sc} in response to forskolin (2 μ M) and 1-EBIO (1 mM). (B) Unidirectional and net Cl⁻ fluxes are shown for the forskolin and forskolin plus 1-EBIO time periods. As in the previous experiments, forskolin increased both unidirectional fluxes without causing a net Cl⁻ secretion. 1-EBIO further increased J_{sm} and caused a net secretion that accounted for 83% of the I_{sc} . Fluxes are plotted as the absolute values and are also summarized in Table III.

table iii

Effects of Forskolin and 1-EBIO on Unidirectional and Net Cl⁻ Fluxes Across Calu-3 Cell Monolayers

	J_{ms}^{Cl}	J_{sm}^{Cl}	J_{net}^{Cl}	I_{sc}	R_T	J_{net}^R
Forskolin	2.30 ± 0.106	2.57 ± 0.096	-0.27 ± 0.105	2.49 ± 0.158	180 ± 7	2.22 ± 0.134
1-EBIO	2.60 ± 0.190	6.14 ± 0.582	-3.54 ± 0.452	4.24 ± 0.192	173 ± 9	0.72 ± 0.347

Units are as given in Table I. Measurements were made before and after the addition of 1-EBIO (1 mM) to the mucosal and serosal solutions of forskolin (2 μ M)-treated monolayers. Values are the mean \pm SEM, $n = 6$ for each unidirectional flux and 12 for J_{net} , I_{sc} , R_T , and J_{net}^R .

sis. Hyperpolarization of the membrane potential would increase the driving force for anion exit of both HCO₃⁻ and Cl⁻ across the apical membrane. However, hyperpolarization of the basolateral membrane potential would also tend to decrease the driving force for basolateral membrane HCO₃⁻ entry on the Na⁺:HCO₃⁻ cotransporter, whose Na⁺ to HCO₃⁻ stoichiometry is reported to be 1:2 or 1:3 in various cell types (Boron and Boulpaep, 1989). A second hypothesis, and one that is not mutually exclusive with the former hypothesis, is that 1-EBIO activates apical membrane anion channels that were not activated by forskolin and that the 1-EBIO-activated channels allow for the preferential exit of Cl⁻ over HCO₃⁻. To test these hypotheses, we performed studies on permeabilized monolayers.

The pore forming antibiotic nystatin was used to permeabilize the apical membrane and a transepithelial mucosal-to-serosal K⁺ gradient was established. After permeabilization, 1-EBIO increased I_K, and this was inhibited by both CTX (Fig. 7 A) and clotrimazole (B).

In 17 experiments, 1-EBIO (1 mM) increased I_K an average of $91 \pm 9 \mu A \cdot cm^{-2}$ and this was inhibited $66 \pm 2\%$ by CTX (50 nM, $n = 10$) and $95 \pm 2\%$ by clotrimazole (10 μ M, $n = 7$). Thus, 1-EBIO does activate basolateral membrane K⁺ channels. In contrast, forskolin (2 μ M) failed to cause an increase in I_K. After the establishment of a mucosal-to-serosal Cl⁻ gradient, the addition of nystatin to the serosal membrane elicited an absorptive I_{Cl} of $58 \pm 9 \mu A \cdot cm^{-2}$ ($n = 24$, Fig. 8). Thus, in contrast to the measurements of I_K, treatment of the monolayers with nystatin appears to uncover or activate a substantial basal I_{Cl}. Similar results were observed in T84 cells studied under the same experimental conditions (Devor et al., 1996). Therefore, this effect of nystatin is not unique to Calu-3 cells. The mechanisms involved in this nystatin induced increase in I_{Cl} are unknown. The subsequent addition of forskolin (10 μ M) to the nystatin-treated monolayers increased I_{Cl} by an additional $186 \pm 15 \mu A \cdot cm^{-2}$ ($n = 7$) (Fig. 8 A). 1-EBIO failed to cause any further increase in I_{Cl} in the

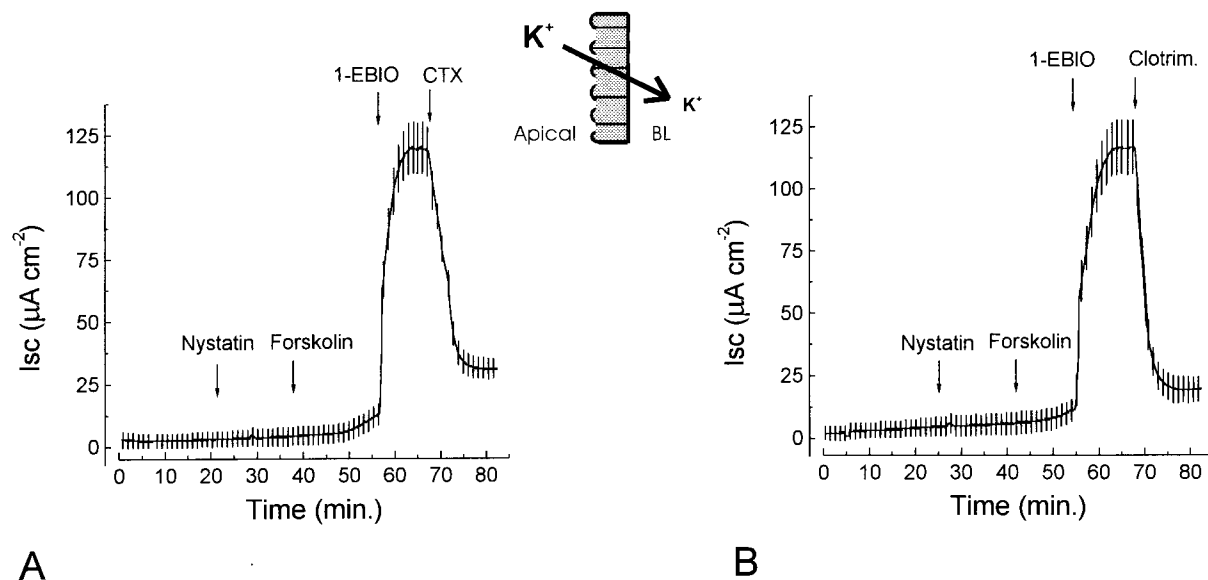

FIGURE 7. Effect of 1-EBIO, CTX, and clotrimazole on basolateral membrane K⁺ currents (I_K) after establishment of a mucosa-to-serosa K⁺ gradient and permeabilization of the mucosal membrane with nystatin. (A) Effects of 1-EBIO (600 μ M) and CTX (50 nM), and (B) effects of 1-EBIO and clotrimazole (10 μ M) on I_K. Monolayer illustration indicates the direction of the ion gradient and the dashed line in the monolayer the permeabilization of the apical membrane with nystatin. Current traces are representative of six experiments with similar results.

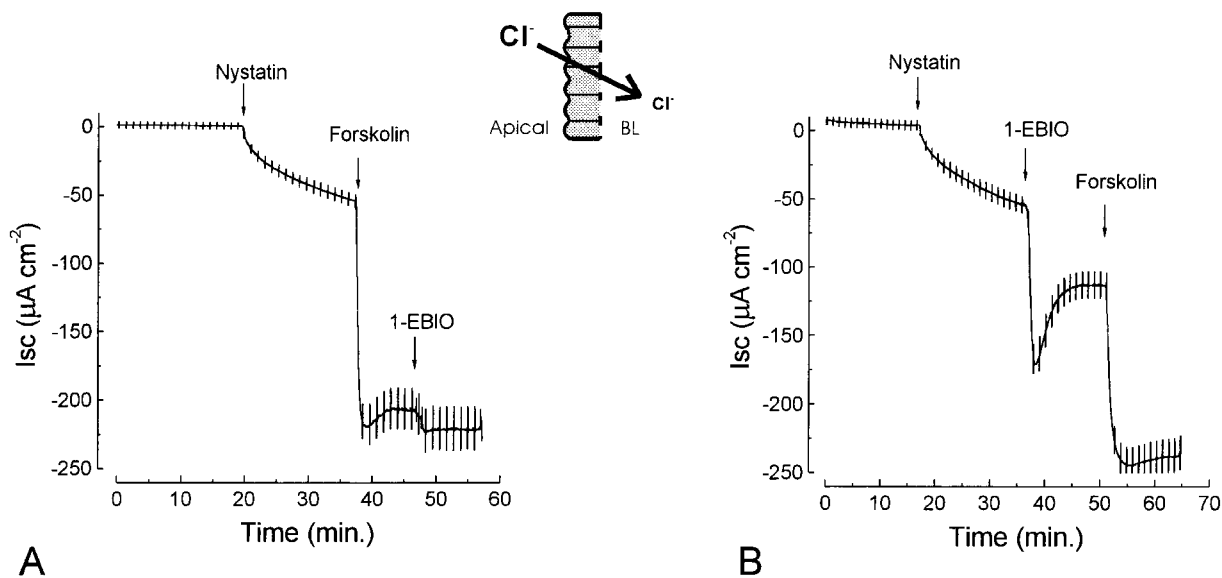

FIGURE 8. Effects of forskolin and 1-EBIO on apical membrane Cl^- currents (I_{Cl}) after establishment of a mucosa-to-serosa Cl^- gradient and permeabilization of the basolateral membrane with nystatin. (A) Effects of forskolin ($2 \mu\text{M}$) and 1-EBIO (1 mM), and (B) effects of 1-EBIO and forskolin on I_{Cl} . The monolayer illustration indicates the direction of the ion gradient and the dashed line in the monolayer indicates the permeabilization of the basolateral membrane with nystatin. Current traces are representative of 24 experiments with similar results.

forskolin treated monolayers. However, 1-EBIO alone when added to the nystatin-treated monolayers increased I_{Cl} by an additional $74 \pm 11 \mu\text{A} \cdot \text{cm}^{-2}$ ($n = 6$) and forskolin further increased I_{Cl} by an additional $110 \pm 12 \mu\text{A} \cdot \text{cm}^{-2}$ ($n = 6$; Fig. 8 B).

Thus, both forskolin and 1-EBIO when added alone can activate an apical membrane Cl^- conductance in nystatin-treated Calu-3 monolayers. Forskolin caused a 2.5-fold greater increase in I_{Cl} compared with the 1-EBIO response. The lack of specific Cl^- channel blockers (Schultz et al., 1999) prevents us from determining whether the same channel or different Cl^- channels are activated by forskolin and 1-EBIO. However, when forskolin and then 1-EBIO was added, the effects on I_{Cl} were not additive, suggesting that forskolin alone can maximally activate the apical Cl^- conductance. Therefore, the effect of 1-EBIO in causing the switch from HCO_3^- secretion to Cl^- secretion appears to result from the activation of basolateral membrane K^+ channels and decreased driving force for HCO_3^- entry across the basolateral membrane. This hypothesis will be considered further in the discussion.

Excised Patch Single Channel Records

The above results indicate that Calu-3 cells express K^+ channels with similar pharmacological characteristics to the K^+ channels we described previously in T84 cells (Devor and Frizzell, 1993; Devor et al., 1996, 1997) and that this conductance may be important in altering the driving force for HCO_3^- entry across the basolateral membrane that elicits Cl^- secretion in Calu-3 cells.

Thus, we wished to characterize this K^+ channel at the single channel level. Inward and outward single-channel currents observed on excision of membrane patches into a symmetric K^+ bath containing 400 nM free Ca^{2+} are shown in Fig. 9 A. Channel activity showed no obvious voltage dependence and required Ca^{2+} in the bath (data not shown). The average current-voltage for four such patches is shown in Fig. 9 B (●). Single channel currents were inwardly rectified with average chord conductance values of $31 \pm 2 \text{ pS}$ at -100 mV and $9 \pm 0.2 \text{ pS}$ at $+100 \text{ mV}$. The K^+ -to- Na^+ selectivity of this channel was assessed by replacing 100 mEq pipette K^+ with Na^+ ; $P_{\text{K}}/P_{\text{Na}}$ was calculated from the Goldman-Hodgkin-Katz relation. Replacing pipette K^+ with Na^+ shifted the reversal potential by -20 mV ($n = 4$; Fig. 9 B, ○). A shift of -27 mV is predicted for a perfectly K^+ selective electrode. From these data, the calculated K^+ -to- Na^+ selectivity ratio is 5.5:1. This conductance and $\text{K}^+:\text{Na}^+$ selectivity values are similar to what has been previously reported for a Ca^{2+} -activated K^+ channel in T84 cells (Devor and Frizzell, 1993; Tabcharani et al., 1994; Roch et al., 1995) as well as primary cultures of canine tracheal epithelial cells (Welsh and McCann, 1985; McCann et al., 1990).

Effect of 1-EBIO on K_{Ca}

We previously demonstrated that 1-EBIO directly activated the K_{Ca} of T84 cells in excised patch-clamp recordings (Devor et al., 1996). Thus, we determined whether 1-EBIO would similarly activate K_{Ca} in excised, inside-out single channel patch-clamp recordings from

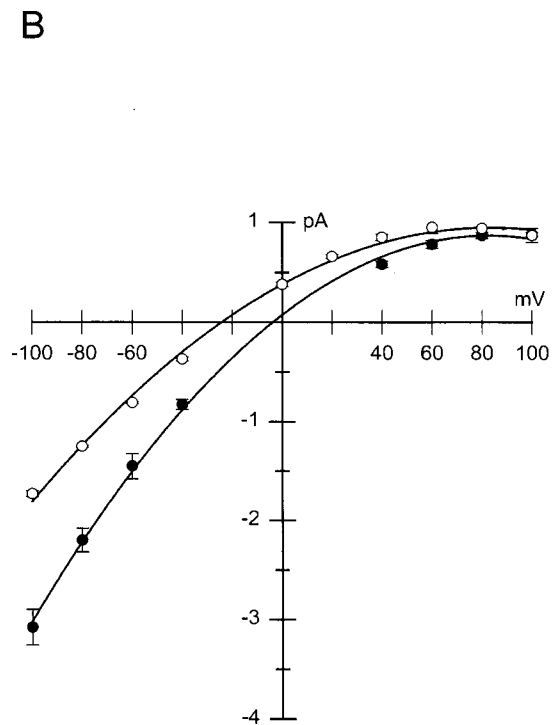
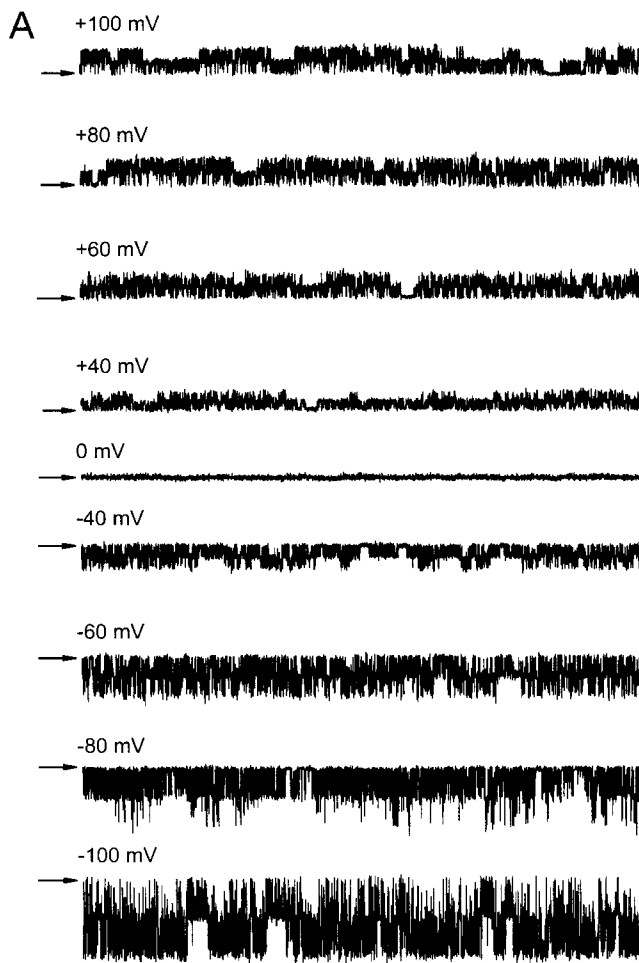

FIGURE 9. (A) Single channel recordings of K_{Ca} from an excised, inside-out patch. Recordings were made at the indicated voltages (referenced to the inside of the membrane) in symmetric K-gluconate solutions. The bath contained 400 nM free Ca^{2+} . The arrows indicate the closed state of the channel. (B) Average current-voltage relationships for K_{Ca} recorded in either symmetric 150 mM K-gluconate (●, $n = 4$) or after replacement of 100 mEq K^+ with Na^+ in the pipette solution (○, $n = 4$).

Calu-3 cells. The effect of 1-EBIO (200 μM) on one patch is shown in Fig. 10. Under control conditions (400 nM free Ca^{2+} in the bath), minimal K_{Ca} channel activity was observed. 1-EBIO produced a large increase in channel activity that was readily reversible after wash-out of the 1-EBIO. In 14 inside-out recordings, 1-EBIO increased nP_o from 0.08 ± 0.02 to 1.68 ± 0.39 . These results indicate that this channel, as in T84 cells, is responsible for the increase in the basolateral membrane K^+ conductance and I_{sc} during an 1-EBIO-mediated secretory response.

Effect of K^+ Channel Blockers

We demonstrate above that the 1-EBIO-induced basolateral membrane K^+ conductance is sensitive to block by CTX and clotrimazole (Fig. 7). We therefore determined whether these inhibitors would block the channel in excised outside-out and inside-out patches. The effect of CTX (50 nM) on K_{Ca} in an outside-out patch is

shown in Fig. 11 A. When holding the patch at -100 mV, addition of CTX to the outside of the channel resulted in a complete inhibition of channel activity. This block was voltage dependent and was partially relieved by voltage clamping the patch to $+100$ mV. The inhibition by CTX was completely reversible. Similar results were obtained in three additional outside-out patches. Clotrimazole (10 μM) also completely inhibited K_{Ca} activity, reducing nP_o from 1.59 ± 0.24 to 0.05 ± 0.02 ($n = 6$; Fig. 11B). Thus, results from these K^+ channel blocker experiments further indicate that 1-EBIO is activating this inwardly rectifying Ca^{2+} -activated K^+ conductance in Calu-3 monolayers resulting in the stimulation of Cl^- secretion and the inhibition of HCO_3^- secretion.

discussion

The results of our studies with Calu-3 cells demonstrate that forskolin stimulates the net secretion of HCO_3^- .

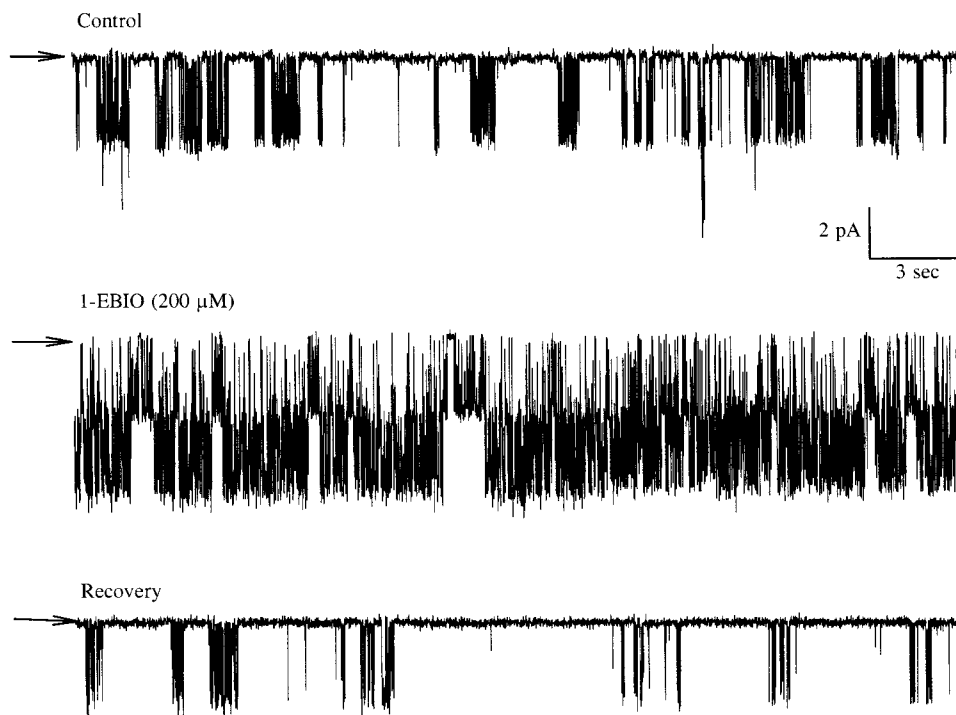

FIGURE 10. Reversible activation of K_{Ca} in an excised, inside-out patch by 1-EBIO (200 μ M) in the presence of 400 nM free Ca^{2+} . Bath and pipette contained symmetric 150 mM K-gluconate and the patch was voltage clamped to -100 mV (inside negative). Arrows indicate the closed state of the channel.

Forskolin consistently caused an increase in I_{sc} to a new sustained plateau. Ion flux studies revealed that this increase in I_{sc} could not be explained by the net transport of Na^+ , Rb^+ , or Cl^- , leaving HCO_3^- secretion as the likely basis for the increase in I_{sc} . Ion substitution experiments demonstrated HCO_3^- , but not Cl^- , was required to elicit a sustained increase in I_{sc} with forskolin. In addition, Na^+ was required in the serosal bath to elicit a forskolin response. Inhibitor studies revealed that the forskolin response was sensitive to ouabain, indicating a role for the Na^+/K^+ -ATPase. The forskolin response was also sensitive to DNDS on the serosal side but not the mucosal side, indicating a role for a basolateral membrane $Na^+:HCO_3^-$ cotransporter or $Cl^-:HCO_3^-$ exchanger. However, because Cl^- was not required and serosal Na^+ was, the effects of DNDS are likely to result from the inhibition of a basolateral membrane $Na^+:HCO_3^-$ cotransporter. Acetazolamide caused a partial inhibition of the forskolin response, consistent with some of the secreted HCO_3^- arising from metabolic sources. The ion flux studies failed to show evidence of net secretion of Cl^- in response to forskolin, and bumetanide did not inhibit the I_{sc} response. Thus, forskolin did not cause the net secretion of Cl^- across Calu-3 cells under short circuit conditions. Rather, we conclude forskolin causes the net secretion of HCO_3^- by a Cl^- -independent, Na^+ -dependent, and DNDS-sensitive electrogenic mechanism in Calu-3 cells. The forskolin-stimulated alkalinization of the mucosal bathing solution of Calu-3 cells, studied

under open circuit conditions, lends further support to this conclusion.

Although forskolin did not stimulate the net secretion of Cl^- , it did cause a fivefold increase in both unidirectional fluxes of Cl^- (Fig. 1 B and Table I) and it is of interest to understand the mechanisms that underly these changes. Our first interpretation was that forskolin increased the transcellular passage of Cl^- in both directions. Thus, the opening of CFTR would allow for both the exit and entry of Cl^- across the apical membrane. The $NaK2Cl$ cotransporter in the basolateral membrane would allow the entry of Cl^- leaving one to explain how Cl^- exits the cell in the serosal-to-mucosal direction. However, bumetanide did not alter the unidirectional fluxes, consistent with the lack of change in the forskolin-stimulated I_{sc} . Thus, the $NaK2Cl$ cotransporter does not appear to mediate the entry of Cl^- across the basolateral membrane in the forskolin-stimulated monolayers. We next entertained the possibility that Cl^- may move across the basolateral membrane on a $Cl^-:HCO_3^-$ exchanger. However, the increases in both unidirectional fluxes in response to forskolin were still observed in HCO_3^- -free buffer. Thus, the increased fluxes do not depend on extracellular HCO_3^- . Because this experiment does not exclude the possibility that a basolateral membrane anion exchanger is operating in a $Cl^-:Cl^-$ exchange mode, we examined the effects of serosal DNDS (1 mM) on the Cl^- fluxes. DNDS cause a 70% decrease in both unidirectional fluxes in the forskolin-stimulated monolayers. Therefore, the increase

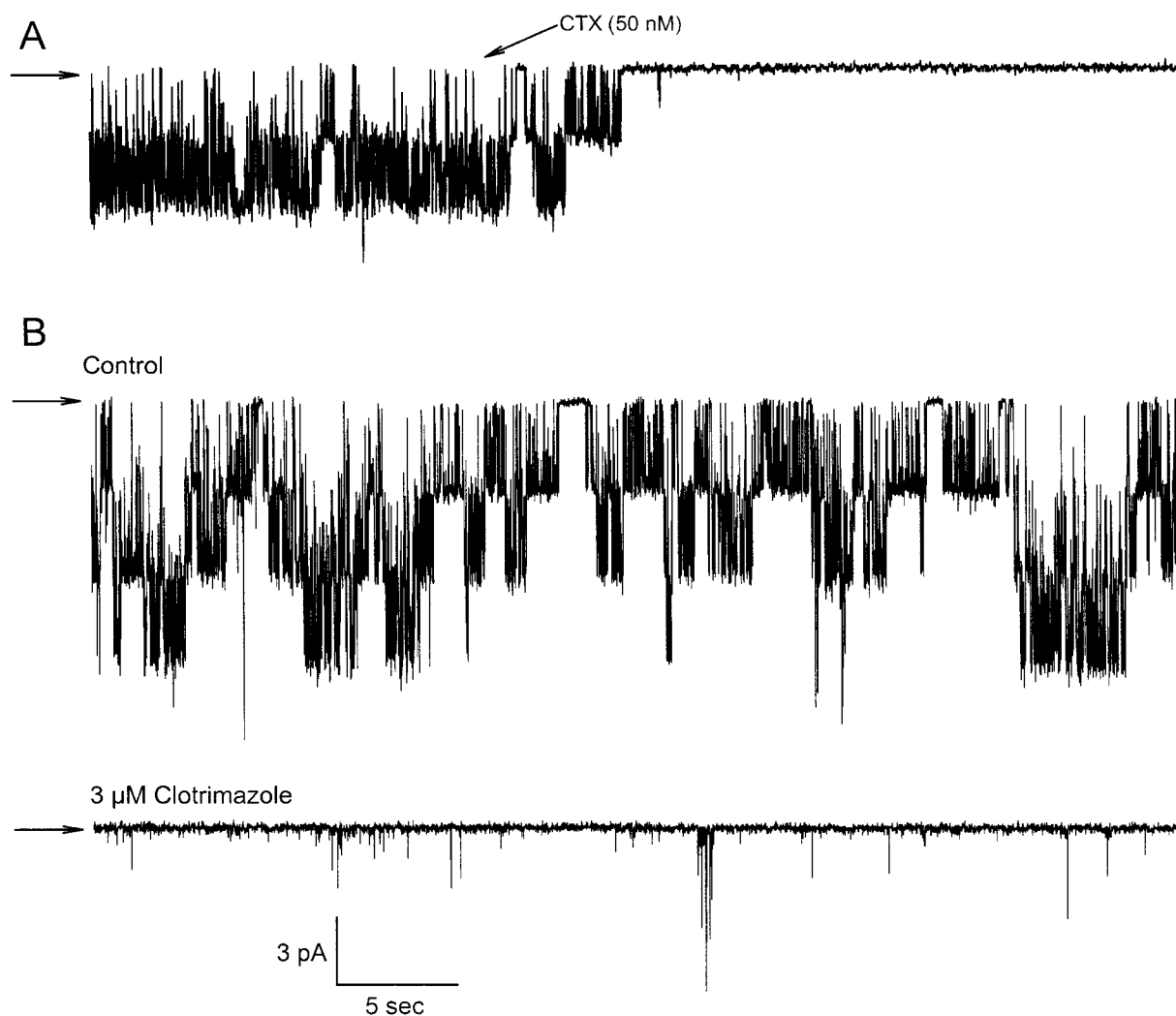

FIGURE 11. Inhibition of K_{Ca} by CTX and clotrimazole. (A) Addition of CTX (50 nM) to the extracellular side of K_{Ca} in an excised, outside-out patch resulted in a complete inhibition of channel activity when the patch was voltage clamped to -100 mV (inside negative). Patch pipette contained 400 nM free Ca^{2+} . (B) Addition of clotrimazole (3 μ M) to the cytoplasmic side of K_{Ca} in an excised inside out patch resulted in a complete inhibition of channel activity at a holding potential of -100 mV. Other conditions as indicated in Fig. 10, the arrows indicate the closed state of the channel.

in Cl^- fluxes caused by forskolin can largely be accounted for by a $Cl^-:Cl^-$ exchange across the basolateral membrane and the exit and entry of Cl^- via CFTR across the apical membrane.

The studies with 1-EBIO demonstrated the Calu-3 cells are not limited to the secretion of HCO_3^- , but rather they can also be stimulated to secrete Cl^- . 1-EBIO, like forskolin, consistently caused a sustained increase in I_{sc} . ^{36}Cl flux studies showed the 1-EBIO-stimulated increase in I_{sc} could be fully accounted for by the net secretion of Cl^- . In addition, both the increase in I_{sc} and the net secretion of Cl^- were inhibited by bumetanide. Studies on permeabilized Calu-3 monolayers revealed 1-EBIO activates both a basolateral membrane K^+ conductance and an apical membrane Cl^- conductance as

previously shown in studies on T84 cells (Devor et al., 1996). CTX and clotrimazole both inhibited the 1-EBIO I_{sc} response as well as the 1-EBIO-activated K^+ current in permeabilized monolayers. Patch-clamp studies demonstrated the presence of an intermediate conductance, inwardly rectified, Ca^{2+} -activated K^+ channel in Calu-3 cells that was activated by 1-EBIO and blocked by CTX and clotrimazole. We and others have also identified a Ca^{2+} -activated K^+ channel with identical biophysical properties and pharmacological profile in T84 cells (Devor and Frizzell, 1993; Tabcharani et al., 1994; Roch et al., 1995; Devor et al., 1996). Moreover, Welsh and McCann (1985) and McCann et al. (1990) have already shown that this channel is expressed in native airway epithelial cells and is therefore not just in

epithelial cell lines. Recently, three different groups have cloned the same K^+ channel, variously referred to as hIK-1, hSK4, and hIK (Ishii et al., 1997; Joiner et al., 1997; Jensen et al., 1998). These channels have identical biophysical properties and pharmacological profile to the channel observed in canine tracheocytes, T84 cells, and Calu-3 cells. Northern blot analysis has confirmed the presence of the mRNA for hIK-1 in T84 and Calu-3 cells (Devor, D.C., unpublished results). Thus, we conclude that one site of action of 1-EBIO is the activation of hIK-1 in the basolateral membrane of Calu-3 cells. Permeabilization of monolayers demonstrated 1-EBIO also activates an apical membrane Cl^- channel; however, the identity of the apical membrane Cl^- channel that is activated by 1-EBIO is less certain. Haws et al. (1994) have reported the predominant Cl^- channel observed in Calu-3 cells is a low conductance channel with properties consistent with those of CFTR. 1-EBIO is a benzimidazolinone and other benzimidazolinones (e.g., NS004 and NS1619) have been reported to activate CFTR (Gribkoff et al., 1994; Champigny et al., 1995). Thus, it is possible that the Cl^- channel activated by 1-EBIO in Calu-3 cells is CFTR. However, further studies will be necessary to confirm this hypothesis.

Calu-3 cells secrete HCO_3^- in response to forskolin

and Cl^- in response to 1-EBIO. However, when the two agonists are added together, anion secretion is dominated by Cl^- secretion and there is a decrease in the net secretion of HCO_3^- . Studies with primary cultures of human bronchial epithelial cells lead Smith and Welsh (1992) to suggest that airway epithelia may also switch between HCO_3^- and Cl^- secretion. Ashton et al. (1991) have also suggested that pancreatic ductal epithelial cells can be differentially stimulated to secrete HCO_3^- or Cl^- . The mechanisms that underlie the switch between HCO_3^- and Cl^- secretion are largely unknown. Our results with Calu-3 cells offer some insight and suggest a model (Fig. 12) to explain how the same cell can secrete HCO_3^- when stimulated by forskolin and Cl^- when stimulated by 1-EBIO or 1-EBIO plus forskolin.

The first tenet of the model is the presence of an anion channel in the apical membrane that can conduct both HCO_3^- and Cl^- . Whether there are two separate channel types, one favoring HCO_3^- and activated by forskolin and one favoring Cl^- and activated by 1-EBIO, or a single channel type that conducts both HCO_3^- and Cl^- is not clear at this time. Nonselective anion channels have been reported but to our knowledge an epithelial anion channel that favors HCO_3^- over Cl^- has

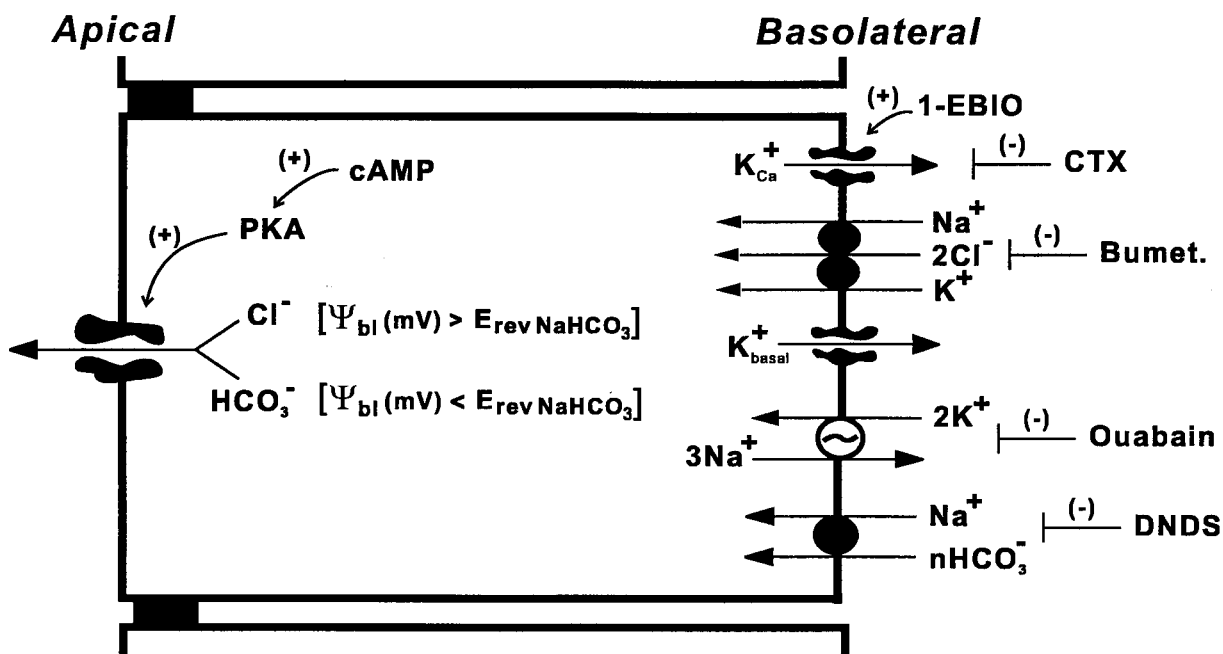

FIGURE 12. Model for Calu-3 anion secretion. Stimulation by cAMP causes the activation of an apical membrane anion channel that conducts both HCO_3^- and Cl^- . We propose this anion channel is CFTR. Activation of CFTR will tend to bring the apical membrane potential to E_{Cl} (about -35 mV), a value greater than the equilibrium potential for HCO_3^- ($E_{HCO_3} = -13$ mV) and thereby provides the driving force for HCO_3^- exit across the apical membrane. Stimulation by cAMP (forskolin) alone leaves the basolateral membrane potential (ψ_{bl}) less hyperpolarized than the reversal potential of the DNDS-sensitive $Na^+ : HCO_3^-$ cotransporter ($E_{rev NaHCO_3}$) and HCO_3^- is secreted. Activation of K_{Ca} by 1-EBIO hyperpolarizes ψ_{bl} so that $\psi_{bl} > E_{rev NaHCO_3}$, and this inhibits HCO_3^- uptake by the $Na^+ : HCO_3^-$ cotransporter but provides the driving force for Cl^- secretion. Whether cAMP activates the $Na^+ : HCO_3^-$ cotransporter is unknown. The stoichiometry, 1:2 or 1:3, of the Calu-3 cell $Na^+ : HCO_3^-$ cotransporter is also unknown.

not yet been described in the literature. Because HCO_3^- secretion is stimulated by forskolin, the anion channel mediating the secretion of HCO_3^- is likely to be activated by cAMP and PKA, as is CFTR. CFTR is highly expressed in Calu-3 cells (Finkbeiner et al., 1993; Shen et al., 1994) and activated by forskolin when measured by anion efflux methods and patch clamp analysis (Haws et al., 1994). Preliminary studies using impedance analysis have shown forskolin does activate an apical membrane anion conductance in Calu-3 cells (Bridges, R.J., unpublished observations). Patch-clamp anion selectivity studies have shown CFTR can conduct HCO_3^- , although at a fraction (0.15–0.25) of the Cl^- conductance (Gray et al., 1990; Poulsen et al., 1994; Linsdell et al., 1997). Heterologous expression of wt-CFTR but not ΔF508 -CFTR in NIH3T3 fibroblasts and C127 mammary cells was shown to confer the cells with a Na^+ -independent, HCO_3^- -dependent, forskolin-regulated intracellular pH recovery mechanism (Poulsen et al., 1994). Illek et al. (1997) have shown, in α -toxin-permeabilized monolayers of Calu-3 cells, the activation of a HCO_3^- current by cAMP with a similar HCO_3^- to Cl^- selectivity as observed in the patch-clamp studies. In addition, Smith and Welsh (1992) demonstrated cAMP-stimulated HCO_3^- secretion across normal but not CF airway epithelia and they suggested HCO_3^- exit across the apical membrane is through the Cl^- channel that is defectively regulated in CF. Thus, we propose that CFTR mediates the exit of HCO_3^- across the apical membrane of Calu-3 cells.

The involvement of an anion channel in HCO_3^- secretion is not a new concept. However, previous models have proposed the anion channel acts as a shunt pathway mediating the exit of Cl^- from the cell (Stetson et al., 1985). Luminal Cl^- is then thought to be used by an apical membrane $\text{Cl}^-:\text{HCO}_3^-$ exchanger that mediates the exit of HCO_3^- from the cell. Thus, this model for HCO_3^- secretion necessitates the presence of luminal Cl^- for the apical membrane exit of HCO_3^- . The studies with Calu-3 cells demonstrate Cl^- is not required for the secretion of HCO_3^- . Ishiguro et al. (1996) have recently reported results on HCO_3^- secretion in interlobular ducts from guinea pig pancreas that demonstrate agonist-stimulated HCO_3^- efflux at low (7 mM) luminal Cl^- concentrations. These authors suggest their results are not easily reconciled with HCO_3^- transport across the luminal membrane being mediated by a $\text{Cl}^-:\text{HCO}_3^-$ exchanger in parallel with a Cl^- conductance. Rather, they too argue for a conductive, channel mediated, exit of HCO_3^- across the apical membrane (Ishiguro et al., 1996). Our findings are consistent with this hypothesis, and they suggest the Calu-3 cells will be a useful cell line to help further test this hypothesis as well as to determine the role of CFTR in apical HCO_3^- exit.

The second tenet of the model (Fig. 12) is the presence of an electrogenic $\text{Na}^+:\text{HCO}_3^-$ cotransporter (NBC) in the basolateral membrane that mediates the entry of HCO_3^- into the cell. Boron and Boulpaep (1983) were the first to describe an electrogenic NBC with $\text{Na}^+:\text{HCO}_3^-$ stoichiometry of 1:3 that mediates the exit of HCO_3^- across the basolateral membrane in the proximal tubule of the tiger salamander *Ambystoma tigrinum*. Romero et al. (1997) using mRNA from the tiger salamander kidney have recently expression cloned this NBC. The cloning of a human homologue of the renal NBC has also recently been reported (Burnham et al., 1997), as has a unique human pancreatic isoform (Abuladze et al., 1998). The stoichiometries of the cloned NBCs have not yet been established but *Xenopus* oocyte expression studies have shown the renal NBC is electrogenic, Na^+ - and HCO_3^- -dependent, Cl^- -independent, and disulfonic stilbene-sensitive (Romero et al., 1997). These characteristics are shared by NBCs studied in kidney, glial, liver, pancreas, and colon (Boron and Boulpaep, 1989). Our studies with Calu-3 cells demonstrate that forskolin-stimulated HCO_3^- secretion also shares these characteristics, consistent with the presence of a NBC in the basolateral membrane. Preliminary reverse transcription-PCR and sequencing studies have shown Calu-3 cells express a NBC (Gangopadhyay and Bridges, unpublished observations) lending further support to this notion. Studies in progress are focused on ascertaining which of the NBC isoforms is expressed in Calu-3 cells as well as the membrane localization, apical versus basolateral, of the cotransporter. According to Fig. 12, we predict a basolateral membrane NBC with a $\text{Na}^+:\text{HCO}_3^-$ stoichiometry that favors the entry of HCO_3^- when Calu-3 cells are stimulated by forskolin. Both the pancreatic and renal isoforms of the NBCs have consensus phosphorylation sites for protein kinase A and therefore may be regulated by cAMP-mediated agonists (Romero et al., 1997; Abuladze et al., 1998). Thus, in addition to the activation of an apical membrane anion channel (CFTR?), forskolin may also activate HCO_3^- entry on the NBC.

Whether a NBC mediates entry or exit of HCO_3^- depends on the stoichiometry of the transporter, the membrane potential, and the concentrations of Na^+ and HCO_3^- inside and outside the cell. Sodium: HCO_3^- stoichiometries of 1:2 and 1:3 have been reported (Boron and Boulpaep, 1989), indicating that turnover of the NBC may result in the transfer of one or two negative charges across the membrane at usual membrane voltages. The 1:2 stoichiometry is associated with NBC-mediated HCO_3^- entry, whereas a 1:3 stoichiometry is consistent with HCO_3^- exit. If one assumes typical ion concentrations of 145 mM Na^+ , 25 mM HCO_3^- outside, and 15 mM Na^+ and 15 mM HCO_3^- inside, then HCO_3^- will enter a cell on the NBC at membrane potentials

less hyperpolarized than -85 mV when the $\text{Na}^+:\text{HCO}_3^-$ stoichiometry is 1:2 and -49 mV when it is 1:3. Membrane potentials more hyperpolarized than these values will lead to HCO_3^- exit from the cells. Thus, the activation of basolateral membrane K^+ channels by 1-EBIO is expected to hyperpolarize the membrane potential, and this will inhibit the entry of HCO_3^- on the NBC. If the hyperpolarization is of sufficient magnitude, this change in driving force may drive HCO_3^- out of the cell across the basolateral membrane. Hyperpolarization will also tend to drive anions (HCO_3^- and Cl^-) out of the cell across the apical membrane. However, because basolateral membrane entry of HCO_3^- becomes inhibited, this apical membrane hyperpolarization will favor Cl^- secretion. Therefore, we propose that the switch between HCO_3^- secretion and Cl^- secretion is determined by the basolateral membrane potential. Differential regulation of the basolateral membrane potential by secretory agonists would provide a means of stimulating HCO_3^- or Cl^- secretion. As shown in Fig. 12, CFTR could serve as both a HCO_3^- and a Cl^- channel mediating the apical membrane exit of either anion depending on the nature of the anion provided by the basolateral membrane cotransporter mechanisms.

Why does forskolin fail to stimulate Cl^- secretion in Calu-3 monolayers? Cyclic AMP-stimulated Cl^- secretion is known to require the activation of both an apical membrane Cl^- conductance and a basolateral membrane K^+ conductance; the former depolarizes and the latter repolarizes the membrane voltage to maintain a driving force for Cl^- exit (Halm and Frizzell, 1990). Permeabilization studies demonstrated forskolin does activate an apical membrane Cl^- conductance (Fig. 8), but that it fails to activate a basolateral membrane K^+ conductance (Fig. 7). Thus, unless the basal K^+ conductance can maintain the apical voltage above the Cl^- equilibrium potential ($E_{\text{Cl}} < -35$ mV, assuming intracellular $\text{Cl}^- = 30$ mM), Cl^- can not be secreted. Indeed, the expected high Cl^- conductance of the apical membrane of forskolin-stimulated Calu-3 cells would set the apical membrane voltage at E_{Cl} and this would provide the driving force for HCO_3^- exit since $E_{\text{HCO}_3^-}$ is -13 mV (assuming intracellular $\text{HCO}_3^- = 15$ mM and extracellular $= 25$ mM).⁴ This electrical coupling may explain the apparent Cl^- dependence of HCO_3^- secretion in some epithelia and further emphasizes the importance of CFTR in Cl^- and HCO_3^- secretion.

⁴Together with the measured net secretion of HCO_3^- of $\sim 60 \mu\text{A} \cdot \text{cm}^{-2}$, one can use the values for $E_{\text{HCO}_3^-}$ (-13 mV) and E_{Cl} (-35 mV) to obtain an estimate of the apical membrane HCO_3^- conductance ($g_{\text{HCO}_3^-}$), where $g_{\text{HCO}_3^-} = (E_{\text{Cl}} - E_{\text{HCO}_3^-})/I_{\text{HCO}_3^-} = 2.7 \text{ mS} \cdot \text{cm}^{-2}$. This estimation assumes the apical membrane is at E_{Cl} . Results from impedance analysis on Calu-3 cells indicate forskolin increases the apical membrane conductance (g_{apical}) to $\sim 20 \text{ mS} \cdot \text{cm}^{-2}$ (Bridges, R.J., unpublished observations). This remarkably high conductance would

If the results we have obtained with Calu-3 cells accurately reflect the transport properties of native submucosal gland serous cells, then HCO_3^- secretion in the human airways warrants greater attention. Calu-3 cell HCO_3^- secretion in response to cAMP-mediated agonists is quite similar to that observed in pancreatic duct cells where mutations in CFTR have profound pathological effects. Pancreatic function in CF patients is characterized by impaired fluid, HCO_3^- , and Cl^- secretion by the ductal epithelial cells, the site of CFTR expression (Durie and Forstner, 1989; Marino et al., 1991). Impaired secretion ultimately leads to destruction of the pancreas by digestive enzymes in the obstructed ducts. The principle secreted ion by the ductal cells is HCO_3^- , which drives Na^+ and water into the lumen by electrical and osmotic coupling. The secreted alkaline fluid serves to regulate the activities of the digestive enzymes and to flush them into the duodenal lumen. Secreted HCO_3^- is also thought to have an osmotic advantage (Hogan et al., 1994). With the aid of carbonic anhydrase, HCO_3^- can quickly combine with protons to make CO_2 and H_2O , and thereby tend to make the fluid hypoosmotic. If the airway submucosal glands and surface epithelium function in an analogous manner, potential roles for HCO_3^- in the airways may include the processing, regulation, and clearance of submucosal gland-derived enzymes, mucus, and antimicrobial agents. Early studies have suggested mucus undergoes a transition from gel to sol at alkaline pH (Forstner et al., 1977) and HCO_3^- secretion could therefore aid in the clearance of mucus from the submucosal glands, a process that is impaired in CF. Airway serous cells also express abundant amounts of carbonic anhydrase (Basbaum et al., 1990), some of which may be of the type IV membrane-associated isoform that could convert the secreted HCO_3^- to CO_2 and H_2O in the lumen of the gland or in the airway surface fluid. The rapid loss of CO_2 during ventilation of the airways would favor a shift in the enzymatic equilibrium toward the conversion of HCO_3^- to H_2O . The volatility of the $\text{HCO}_3^-/\text{CO}_2$ buffer system, especially at an air-liquid interface, while having potential physiological significance, will also make the investigation of HCO_3^- secretion in the airways a formidable challenge to the experimentalist. Studies with Calu-3 cells will provide a means to further investigate the mechanisms involved in serous cell HCO_3^- secretion, and perhaps with this knowledge how to better study HCO_3^- secretion in the intact airways.

ensure the apical membrane potential is at or near E_{Cl} , but also yields a HCO_3^- to Cl^- conductance ratio of ~ 0.15 (where $g_{\text{Cl}} = g_{\text{apical}} - g_{\text{HCO}_3^-} = 20 - 2.7 = 17.3 \text{ mS} \cdot \text{cm}^{-2}$ so that $g_{\text{HCO}_3^-}/g_{\text{Cl}} = 2.7/17.3 = 0.15$), a value in good agreement with the patch clamp estimates of 0.15–0.25 for CFTR. Moreover, an apical membrane g_{Cl} of $17.3 \text{ mS} \cdot \text{cm}^{-2}$ means a driving force of only 3.5 mV is required to achieve a net Cl^- secretion of $60 \mu\text{A} \cdot \text{cm}^{-2}$.

We gratefully acknowledge the excellent technical assistance of Mr. Matthew Green, M. Cheng Zhang Shi, and Ms. Maitrayee Sahu. We thank Ms. Michele Dobransky for the superior secretarial assistance in preparing the manuscript.

This work was supported by Cystic Fibrosis Foundation (CFF) grant Devor96PO (to D.C. Devor) and National Institute of Diabetes and Digestive and Kidney Disease grants DK45970 (to R.J. Bridges) and DK46588 (to R.A. Frizzell). A.C. DeLuca is a CFF fellow (DeLuca98DO) and R.J. Bridges is a CFF Research Scholar (E841).

Original version received 22 December 1998 and accepted version received 9 March 1999.

references

- Abuladze, N., I. Lee, D. Newman, J. Hwang, K. Boorer, A. Pushkin, and I. Kurtz. 1998. Molecular cloning, chromosomal localization, tissue distribution, and functional expression of the human pancreatic sodium bicarbonate cotransporter. *J. Biol. Chem.* 273: 17689.
- Ashton, N., B.E. Argent, and R. Green. 1991. Characteristics of fluid secretion from isolated rat pancreatic ducts stimulated with secretin and bombesin. *J. Physiol. (Lond.)* 435:533–546.
- Basbaum, C.B., B. Jany, and W.E. Finkbeiner. 1990. The serous cell. *Annu. Rev. Physiol.* 52:97–113.
- Boat, T.F., M.J. Welsh, and A.L. Beaudet. 1989. Cystic fibrosis. In *The Metabolic Basis of Inherited Disease*. C.R. Scriver, A.L. Beaudet, W.S. Sly, and D. Valle, editors. McGraw-Hill, Inc., New York. 2649–2680.
- Boron, W.F., and E.L. Boulpaep. 1983. Intracellular pH regulation in the renal proximal tubule of the salamander. *J. Gen. Physiol.* 81:53–94.
- Boron, W.F., and E.L. Boulpaep. 1989. The electrogenic Na/HCO₃ cotransporter. *Kidney Int.* 36:392–402.
- Boron, W.F., and R.C. Knakal. 1989. Intracellular pH-regulating mechanism of the squid axon. Interaction between DNDS and extracellular Na⁺ and HCO₃⁻. *J. Gen. Physiol.* 93:123–150.
- Bridges, R.J., W. Rummel, and B. Simon. 1983. Forskolin induced chloride secretion across the isolated mucosa of rat colon descendens. *Arch. Pharmacol.* 323:355–360.
- Burnham, C.E., H. Amlal, Z. Wang, G.E. Shull, and M. Soleimani. 1997. Cloning and functional expression of a human kidney Na⁺:HCO₃-cotransporter. *J. Biol. Chem.* 272:19111–19114.
- Champigny, G., J.L. Imler, E. Puchelle, W. Dalemans, V. Gribkoff, J. Hinrasky, K. Dott, P. Barbry, A. Pavirani, and M. Lazdunski. 1995. A change in gating mode leading to increased intrinsic Cl⁻ channel activity compensates for defective processing in a cystic fibrosis mutant corresponding to a mild form of the disease. *EMBO (Eur. Mol. Biol. Organ.) J.* 14:2417–2423.
- Devor, D.C., and R.A. Frizzell. 1993. Calcium-mediated agonists activate an inwardly rectified K⁺ channel in colonic secretory cells. *Am. J. Physiol.* 265:C1271–C1280.
- Devor, D.C., A.K. Singh, R.A. Frizzell, and R.J. Bridges. 1996. Modulation of Cl⁻ secretion by benzimidazolones. I. Direct activation of a Ca²⁺-dependent K⁺ channel. *Am. J. Physiol.* 271:L775–L784.
- Devor, D.C., A.K. Singh, A.C. Gerlach, R.A. Frizzell, and R.A. Bridges. 1997. Inhibition of intestinal Cl⁻ secretion by clotrimazole: direct effect on basolateral membrane K⁺ channels. *Am. J. Physiol.* 273:C531–C540.
- Durie, P.R., and G.G. Forstner. 1989. Pathophysiology of the exocrine pancreas in cystic fibrosis. *J. R. Soc. Med.* 82:2–10.
- Engelhardt, J.F., M. Zepeda, J.A. Cohn, J.R. Yankaska, and J.M. Wilson. 1994. Expression of the cystic fibrosis gene in adult human lung. *J. Clin. Invest.* 93:737–749.
- Finkbeiner, W.E., S.D. Carrier, and C.E. Teresi. 1993. Reverse transcription-polymerase chain reaction (RT-PCR) phenotypic analysis of cell cultures of human tracheal epithelium, tracheobronchial glands, and lung carcinomas. *Am. J. Respir. Cell Mol. Biol.* 9:547–556.
- Forstner, J.F., I. Jabbal, B.P. Findlay, and G.G. Forstner. 1977. Interaction of mucins with calcium, H⁺ ion and albumin. *Mod. Probl. Paediatr.* 19:54–65.
- Garcia, M.L., H.-G. Knaus, P. Munujos, R.S. Slaughter, and G.J. Kaczorowski. 1995. Charybdotoxin and its effects on potassium channels. *Am. J. Physiol.* 269:C1–C10.
- Gray, M.A., C.E. Pollard, A. Harris, L. Coleman, J.R. Greenwell, and B.E. Argent. 1990. Anion selectivity and block of the small-conductance chloride channel on pancreatic duct cells. *Am. J. Physiol.* 259:C752–C761.
- Gribkoff, V.K., G. Champigny, P. Barbry, S.I. Dworetzky, N.A. Meanwell, and M. Lazdunski. 1994. The substituted benzimidazolone NS004 is an opener of the cystic fibrosis chloride channel. *J. Biol. Chem.* 269:10983–10986.
- Halm, D.R., and R.A. Frizzell. 1990. Intestinal chloride secretion. In *Textbook of Secretory Diarrhea*. E. Lebenthal and M. Duffey, editors. Raven Press, Ltd., New York. 47–58.
- Haws, C., W.E. Finkbeiner, J.H. Widdicombe, and J.J. Wine. 1994. CFTR in Calu-3 human airway cells: channel properties and role in cAMP-activated Cl⁻ conductance. *Am. J. Physiol.* 266:L502–L512.
- Hogan, D.L., M.A. Ainsworth, and J.I. Isenberg. 1994. Review article: gastroduodenal bicarbonate secretion. *Aliment. Pharmacol. Ther.* 8:475–488.
- Illek, B., J.R. Yankaskas, and T.E. Machen. 1997. cAMP and genistein stimulate HCO₃⁻ conductance through CFTR in human airway epithelia. *Am. J. Physiol.* 272:L752–L761.
- Ishiguro, H., M.C. Steward, R.W. Wilson, and R.M. Case. 1996. Bicarbonate secretion in interlobular ducts from guinea-pig pancreas. *J. Physiol. (Camb.)* 495:179–191.
- Ishii, T.M., C. Silvia, B. Hirschberg, C.T. Bond, J.P. Adelman, and J. Maylie. 1997. A human intermediate conductance calcium-activated potassium channel. *Proc. Natl. Acad. Sci. USA.* 94:11651–11656.
- Jacquot, J., E. Puchelle, J. Hinrasky, C. Fuchey, C. Bettinger, C. Spilmont, N. Bonnet, A. Dieterle, D. Dreyer, A. Pavirani, and W. Dalemans. 1993. Localization of the cystic fibrosis transmembrane conductance regulator in airway secretory glands. *Eur. Respir. J.* 6:169–176.
- Jensen, B.S., D. Strobaek, P. Christophersen, T.D. Jorgensen, C. Hansen, A. Silahtaroglu, S.P. Olesen, and P.K. Ahring. 1998. Characterization of the cloned human intermediate-conductance Ca²⁺-activated K⁺ channel. *Am. J. Physiol.* 275:C848–C856.
- Joiner, W.J., L.Y. Wang, M.D. Tang, and L.M. Kaczmarek. 1997. hSK4, a member of a novel subfamily of calcium-activated potassium channels. *Proc. Natl. Acad. Sci. USA.* 94:11013–11018.
- Lee, M.C., C.M. Penland, J.H. Widdicombe, and J.J. Wine. 1998. Evidence that Calu-3 human airway cells secrete bicarbonate. *Am. J. Physiol.* 274:L450–L453.
- Linsdell, P., J.A. Tabcharani, J.M. Rommens, Y.-X. Hou, X.-B. Chang, L.-C. Tsui, J.R. Riordan, and J.W. Hanrahan. 1997. Permeability of wild-type and mutant cystic fibrosis transmembrane

- conductance regulator chloride channels to polyatomic anions. *J. Gen. Physiol.* 110:355–364.
- Lohrmann, E., I. Burhoff, R.B. Nitschke, H.J. Lang, D. Mania, H.C. Englert, M. Hropot, R. Warth, W. Rohm, M. Bleich, and R. Greger. 1995. A new class of inhibitors of cAMP-mediated Cl⁻ secretion in rabbit colon, acting by the reduction of cAMP-activated K⁺ conductance. *Eur. J. Physiol.* 429:517–530.
- Loussouarn, G., F. Charpentier, R. Mohammad-Panah, K. Kunzelmann, I. Baro, and D. Escande. 1997. KvLQT1 potassium channel but not IsK is the molecular target for trans-6-cyano-4-(*N*-ethylsulfonyl-*N*-methylamino)-3-hydroxy-2,2-chromane. *Mol. Pharmacol.* 52:1131–1136.
- Marino, C.R., L.M. Matovcik, F.S. Gorelick, and J.A. Cohn. 1991. Localization of the cystic fibrosis transmembrane conductance regulator in pancreas. *J. Clin. Invest.* 88:712–716.
- McCann, J.D., J. Matsuda, M. Garcia, G. Kaczorowski, and M.J. Welsh. 1990. Basolateral K⁺ channels in airway epithelia. I. Regulation by Ca²⁺ and block by charybdotoxin. *Am. J. Physiol.* 258:L334–L342.
- Moon, S., M. Singh, M.E. Krouse, and J.J. Wine. 1997. Calcium-stimulated Cl⁻ secretion in Calu-3 human airway cells requires CFTR. *Am. J. Physiol.* 273:L1208–L1219.
- Muallem, S., T. Beeker, and S.J. Pandol. 1988. Role of Na⁺/Ca²⁺ exchange and the plasma membrane Ca²⁺ pump in hormone-mediated Ca²⁺ efflux from pancreatic acini. *J. Membr. Biol.* 102:153–162.
- Newman, E.A. 1991. Sodium-bicarbonate cotransport in retinal muller (glial) cells of the salamander. *J. Neurosci.* 11:3972–3983.
- Poulsen, J.H., H. Fischer, B. Illek, and T.E. Machen. 1994. Bicarbonate conductance and pH regulatory capability of cystic fibrosis transmembrane conductance regulator. *Proc. Natl. Acad. Sci. USA.* 91:5340–5344.
- Roch, B., I. Baro, A.S. Hongre, and D. Escande. 1995. ATP-sensitive K⁺ channels regulated by intracellular Ca²⁺ and phosphorylation in normal (T84) and cystic fibrosis (CFPAC-1) epithelial cells. *Pflügers Arch.* 429:355–363.
- Romero, M.F., M.A. Hediger, E.L. Boulpaep, and W.F. Boron. 1997. Expression cloning and characterization of a renal electrogenic Na⁺/HCO₃-cotransporter. *Nature.* 387:409–413.
- Schultz, B.D., A.K. Singh, D.C. Devor, and R.J. Bridges. 1999. Pharmacology of CFTR chloride channel activity. *Physiol. Rev.* 79:S109–S144.
- Shen, B.-Q., W.E. Finkbeiner, J.J. Wine, R.J. Mrsny, and J.H. Widdicombe. 1994. Calu-3: a human airway epithelial cell line that shows cAMP-dependent Cl⁻ secretion. *Am. J. Physiol.* 266:L493–L501.
- Singh, M., M. Krouse, S. Moon, and J.J. Wine. 1997. Most basal I_{SC} in Calu-3 human airway cells is bicarbonate-dependent Cl⁻ secretion. *Am. J. Physiol.* 272:L690–L698.
- Smith, J.J., S.M. Travis, E.P. Greenberg, and M.J. Welsh. 1996. Cystic fibrosis airway epithelia fail to kill bacteria because of abnormal airway surface fluid. *Cell.* 85:229–236.
- Smith, J.J., and M.J. Welsh. 1992. cAMP stimulates bicarbonate secretion across normal, but not cystic fibrosis airway epithelia. *J. Clin. Invest.* 89:1148–1153.
- Stetson, D.L., R. Beauwens, J. Palmisano, P.P. Mitchell, and P.R. Steinmetz. 1985. A double-membrane model for urinary bicarbonate secretion. *Am. J. Physiol.* 249:F546–F552.
- Tabcharani, J.A., R.A. Harris, A. Boucher, J.W. Eng, and J.W. Hanrahan. 1994. Basolateral K channel activated by carbachol in the epithelial cell line T84. *J. Membr. Biol.* 142:241–254.
- Welsh, M.J., and J.D. McCann. 1985. Intracellular calcium regulates basolateral potassium channels in a chloride-secreting epithelium. *Proc. Natl. Acad. Sci. USA.* 82:8823–8826.
- White, J.F. 1989. Conductive pathways for HCO₃⁻ in basolateral membrane of salamander intestinal cells. *Am. J. Physiol.* 257:C252–C260.